

# Quality Insulation Installation (QII) Handbook



For Installers and HERS Raters

2019 Energy Code



Version: October 14, 2019

## Acknowledgements

CalCERTS gratefully acknowledges Russ King and Roy Mittleider as the primary author of the QII handbook. The following members provided content review, formatting and editing: Roy Mittleider. Additionally, this manual includes material from California Energy Commission (CEC) publications on the relevant energy codes for QII.

### **Copyright: ©2019 All Rights Reserved**

This manual is the copyrighted intellectual property of CalCERTS, Inc. It may not be copied in whole or in part without express written consent from CalCERTS, Inc. It is intended for Energy Consultants, Builders, Installers, and CalCERTS, Inc. certified Raters.

The content including text, graphics, and images is protected by copyright under United States law. It is unlawful to modify, reproduce, publicly perform, or distribute the material for the purpose of financial gain. CalCERTS, Inc. is not liable to any party for any direct, indirect, incidental, punitive, or consequential damages (including without limitation business losses; loss of revenue, income, profits or anticipated savings; loss of contracts or business relationships; or loss of reputation or goodwill) as a result of the use, application, or adaptation of materials included herein.

*Note: Structural Insulated Panels (SIPs) and Insulated Concrete Forms (ICFs) are not covered in this document – Refer to RA3.5.7 and RA3.5.8 for these types of insulated assemblies.*

**DISCLAIMER:** This QII Handbook has been created by CalCERTS, Inc. as a courtesy to the public. Due to the complex nature of the California Energy Code (the Standards or the Code), CalCERTS, Inc. does not warranty the accuracy of the final interpretation and applicability to the code. Interpretation of the Standards is a complex process and can be presented with differing points of view. The Standards undergo constant review and scrutiny and are subject to change without written notice. The reader of this QII Handbook is encouraged to verify the final interpretation and accuracy of the material within this document by contacting the California Energy Commission (CEC) Energy Standards Hotline:

Phone 800-772-3300 or email: [Title24@energy.ca.gov](mailto:Title24@energy.ca.gov).

## TABLE OF CONTENTS

<b>1. INTRODUCTION .....</b>	<b>1</b>
General Organization of this Chapter .....	2
The Compliance Process: 1 – 2 - 3 .....	3
Certificates.....	3
<i>Reference: RA3.5.X.1.3</i> .....	3
Certificates and Availability .....	3
<i>Reference: RA3.5.X.1.4</i> .....	3
Coordination is Critical.....	3
Organization RA3.5 .....	4
<b>2. QUALITY INSULATION INSTALLATION PROCEDURES .....</b>	<b>5</b>
Purpose and Scope of these Procedures .....	5
<b>3. IMPORTANT DEFINITIONS .....</b>	<b>6</b>
Continuous Air Barrier .....	6
Air-tight.....	8
Compression .....	9
Delaminated.....	10
Draft Stops .....	10
Friction Fit.....	11
Gaps .....	12
Hard Covers .....	13
Inset Stapling.....	14
Minimally Expansive Foam .....	17
Net Free Area (NFA) .....	18
Baffle, Eave Vent .....	19
Voids and Air Spaces .....	20
<b>4. IMPORTANCE OF DEFINING THE THERMAL BOUNDARY .....</b>	<b>21</b>
<b>5. INSPECTION - AIR BARRIER.....</b>	<b>24</b>
Floors .....	25
Ceiling.....	28
Recessed Can Lighting.....	30
Exhaust Ventilators .....	31
Electrical Boxes .....	31
Fire Sprinklers .....	32
HVAC Register Boots .....	32
Flue Pipes .....	33
Attic Access Hatch.....	35
Wall Cavities .....	36
Windows and doors .....	40
Cantilevered Floors .....	41
<b>6. INSULATION TYPES.....</b>	<b>42</b>
Thermal Specifications: <b>Batt and Blanket</b> .....	42
Thermal Specifications: <b>Loose fill</b> .....	43
Thermal Specifications: <b>Rigid Foam Board</b> .....	45
Thermal Specifications: <b>Spray Polyurethane Foam (SPF)</b> .....	46
Thermal Specifications: <b>Closed Cell SPF - ccSPF</b> .....	47

Thermal Specifications: <b>Open Cell SPF</b> - ocSPF .....	49
<b>7. INSULATION INSPECTION .....</b>	<b>51</b>
Thermal Specification .....	53
R-Value Measurement: <b>Batt Insulation</b> .....	53
R-Value Measurement: <b>Blown-in Insulation</b> .....	54
R-Value Measurement: <b>Rigid Insulation</b> .....	55
R-Value Measurement: <b>SPF Insulation</b> .....	56
<b>8. GENERAL REQUIREMENTS FOR WALLS, ROOF/CEILINGS AND FLOORS: ALL MATERIALS .....</b>	<b>57</b>
Walls, Roof/Ceilings and Floors: <b>Batt and Blanket</b> .....	59
Walls, Roof/Ceilings and Floors: <b>Loose Fill</b> .....	59
Walls, Roof/Ceilings and Floors: <b>Rigid Board</b> .....	59
Walls, Roof/Ceilings and Floors: <b>SPF</b> .....	60
<b>9. SPECIFIC REQUIREMENTS FOR WALL INSULATION .....</b>	<b>61</b>
Wall Insulation: <b>Batt and Blanket</b> .....	62
Wall Insulation: <b>Loose Fill</b> .....	63
Wall Insulation: <b>Rigid</b> .....	63
Wall Insulation: <b>SPF</b> .....	64
Narrow-Framed Cavities .....	65
<b>10. SPECIAL SITUATIONS .....</b>	<b>66</b>
Special Situations - Installation Prior to Exterior Sheathing or Lath.....	66
Special Situations - Obstructions .....	68
Special Situations - Rim Joists .....	69
Special Situations - Knee walls and Skylight Shafts.....	70
Covered Porches/Knee Wall .....	72
Special Situations - HVAC/Plumbing Closet.....	74
Special Situations - Double Walls and Framed Bump Outs .....	75
Special Situations - Structural Bracing, Tie-downs and Steel Structural Framing .....	76
Special Situations - Window and Door Headers .....	77
<b>11. SPECIFIC REQUIREMENTS FOR ROOF/CEILINGS .....</b>	<b>78</b>
Roof/Ceilings - <b>Batt and Blanket Insulation</b> .....	78
Roof/Ceilings - <b>Loose Fill Insulation</b> .....	79
Roof/Ceilings: <b>Rigid Insulation</b> .....	82
Roof/Ceilings: <b>SPF Insulation</b> .....	82
Special Situations - Enclosed Rafter Ceilings.....	83
Gable Ends in Unvented Attics .....	84
Special Situations - HVAC Platform.....	85
Special Situations - Attic Access.....	87
<b>12. RAISED FLOORS .....</b>	<b>89</b>
Homes with Conditioned Space over a Garage .....	90
Homes with Unconditioned Space over a Garage .....	92
The "Cookie Cutter" Test.....	93
Procedure .....	94
<b>13. THE QII CHECKLISTS .....</b>	<b>96</b>
<b>14. HOW TO READ THE INSULATION REQUIREMENTS ON A CF1R-PRF-01 .....</b>	<b>105</b>
<b>15. QII Process by Construction Phase.....</b>	<b>107</b>



## What's New for 2019 QII?

- Quality Insulation Installation (QII) is now a prescriptive requirement for all single-family buildings in all climate zones, and for multifamily buildings in all climate zones except Climate Zone 7 ([§150.1\(c\)1E](#)):

**NOTE:** All buildings shall comply with the Quality Insulation Installation (QII) requirements shown in [TABLE 150.1-A](#) or [TABLE 150.1-B](#). When QII is required, insulation installation shall meet the criteria specified in Reference Appendix RA3.5.

- The prescriptive requirement for quality insulation installation (QII) is not required for additions that are 700 square feet or less ([§150.2\(a\)1B](#)).
- Compression of insulation is now limited to no more than 30% of its nominal thickness, as compared to 50% in 2016.
- Compliance documents include the ENV-21 and ENV-22. The ENV-23 has been omitted. The checklists have been revised on these forms.
- ocSPF: Depressions in the foam insulation surface shall not be greater than 1/2-inch (2016 was not greater than 1 inch) of the required thickness provided these depressions do not exceed 10% of the surface area being insulated.
- RA3.5.4.3(L) Loose fill insulation is now allowed 14 days for settling, rather the 7 days.
- RA3.5.X.3(X) Insulation shall cover all recessed lighting fixtures. If the fixtures are not rated for insulation contact (IC) and air tight (AT), the fixtures shall be removed and/or replaced.
- ENV-21 (I-01) Multifamily Air Barriers require each dwelling unit to be sealed to stop air movement between dwelling units. Treat adjacent dwelling units as unconditioned space for air sealing

## 1. Introduction

Quality Insulation Installation (QII) is a procedure for ensuring that thermal insulation has been properly installed and that air sealing has been properly done in a home. It is based on industry standards (NAIMA) and similar to widely recognized national standards (RESNET and Energy Star), but it also has some unique requirements. Much of QII is simply installing insulation as the manufacturers intended.

When QII is required, it will be clearly indicated on the CF1R Certificate of Compliance and the appropriate CF2R Certificates of Installation and CF3R Certificates of Verification will be required to be completed and signed in the HERS registry.

It is worth noting that of all the HERS verified measures, QII has the highest fail rate. This is partly due to the fact that it requires very precise coordination between the Rater, the installer, and the general contractor/builder. It is also partly due to the fact that the industry still has a long way to go until standard practice is anything near what would pass QII. High turnover by installers is a known issue, as well. It is difficult to keep trained installers from moving on to more prestigious (and less itchy) construction jobs.

The current state of industry standard practice did not get this bad overnight, it evolved over time. One of the causes is the common use of paying installers for “piece work.” That is, paying them for each house completed, rather than paying them by the hour. This encourages installers to work faster and results in generally sloppy work. Passing the QII protocols requires that the installers slow down and exercise much more care and precision, attention to detail is critical. Although it has been deemed cost-effective by the CEC, QII can have a significant impact on the cost of installation. Installing contractors need to be very aware of the requirements and should bid jobs accordingly.

Coordination between designers and the trades is critical. Passing QII is not completely the responsibility of the installer. Architects and framers are finding that they too have gotten sloppy on how a home’s thermal boundary and air barrier are defined and constructed. Framing details need to be clearly spelled out to show a continuous air barrier, for example: where a wall transitions from an exterior wall to an attic knee wall, or when floor joists extend to an attic.

## General Organization of this Chapter

This document is essentially a simplified, yet enhanced version of the official QII protocols, Reference Appendices Section RA3.5. The text from that document has been simplified to eliminate repetitive sections and is enhanced with diagrams, photos and explanations. If there is a conflict between this document and RA3.5, RA3.5 always takes precedence.

In this document, when you see an RA section number that has an "X" in it, such as RA3.5.X.2.1, this means that repetitive text from multiple sections in the Reference Appendices has been combined into a single section in this document. To determine the original RA3.5 section for a specific type of insulating material, replace the X with:

"3" for Batt and Blanket

"4" for Loose fill

"5" for Rigid

"6" for Spray-on Polyurethane Foam (SPF)

For example, notice how the text in these four sections are almost identical:

### [RA3.5.3](#)

These procedures detail the installation and inspection protocols necessary to qualify for Quality Insulation Installation (QII) of **batt and blanket insulation**. These procedures must be field verified before the building construction permit is finalized.

### [RA3.5.4](#)

These procedures detail the installation and inspection protocols necessary to qualify for Quality Insulation Installation (QII) of **loose-fill insulation**. These procedures must be field verified before the building construction permit is finalized.

### [RA3.5.5](#)

These procedures detail the installation and inspection protocols necessary to qualify for Quality Insulation Installation (QII) of **rigid board insulation sheathing material**. These procedures must be field verified before the building construction permit is finalized.

### [RA3.5.6](#)

These procedures detail the installation and inspection protocols necessary to qualify for Quality Insulation Installation (QII) of **spray polyurethane foam (SPF) insulation**. These procedures must be field verified before the building construction permit is finalized.

In this document, it was all combined into:

### **RA3.5.X**

These procedures detail the installation and inspection protocols necessary to qualify for Quality Insulation Installation (QII) of (all types of insulation). These procedures must be field verified before the building construction permit is finalized in order to claim QII energy compliance.

## The Compliance Process: 1 – 2 - 3

In concept, the compliance process is quite simple.

### **Step 1 – Determine what is required**

This is done by the energy consultant and/or designer. The insulation requirements are documented on the CF1R-PRF-01, which must be consistent with the plans and specifications.

### **Step 2 – Install insulation that meets the requirements**

- [CF2R-ENV-03](#) - This form is a detailed list of the assemblies and the type of products used.
- [CF2R-ENV-21](#) - A declaration by the installer that all applicable framing stage requirements of QII were met.
- [CF2R-ENV-22](#) - A declaration by the installer that all applicable insulation stage requirements of QII were met.

### **Step 3 – Verify what was installed**

This is documented on the: CF3R-ENV-21 and 22, which correspond to the like-numbered CF2R forms but are filled out and signed by the HERS Rater.

## Certificates

Reference: [RA3.5.X.1.3](#)

Insulation Certificates of Installation (CF2R's) signed by the insulation installer shall be completed in the HERS registry and state the installation is consistent with the CF1R, and plans and specifications for which the building permit was issued. The insulation installer shall also attach a product specification or data sheet for every insulation material used.

## Certificates and Availability

Reference: [RA3.5.X.1.4](#)

The Insulation Certificates of Installation (CF2R's), with insulation material labels or specification/data sheets attached, signed by the insulation installer shall be available on the building site for each of the HERS Rater's verification inspections. The HERS Rater cannot verify compliance credit without these completed forms. This can be done digitally if the information is available in electronic format (PDF or scanned images).

## Coordination is Critical

It is very important that the general contractor, the insulation installer and the HERS Rater work very closely together. Everyone needs to know exactly what is expected BEFORE the HERS Rater does the inspections. If there are any strange situations or if any of the requirements are unclear, they should be discussed in advance.

Sometimes unique situations may require the involvement of CalCERTS Field Support or even Energy Commission staff.

The most difficult part of QII is probably the logistics of getting the HERS Rater out during a very small window of opportunity before the insulation gets covered up. **If insulation gets covered up prior to the HERS Rater seeing it, this is an automatic FAIL.** Your choices at that point are to expose the insulation (remove the sheetrock) which can be extremely costly to the builder.

### Organization RA3.5

The HERS QII verification protocols defined in *Residential Appendix RA3.5* repeat the same code language for each common type of insulation, with material specific details added to each section as applicable. Although the fundamental principles of QII remain unchanged for all insulation types, there are some important variations in the verification process specific to each type of insulation.

Overview of QII Protocols in RA3.5	
RA3.5.3	Batt and Blanket Insulation
RA3.5.4	Loose Fill Insulation
RA3.5.5	Rigid Board Insulation
RA3.5.6	Spray Polyurethane Foam (SPF)
RA3.5.7	Structural Insulated Panel (SIP)
RA3.5.8	Insulated Concrete Form (ICF)

## 2. Quality Insulation Installation Procedures

### Purpose and Scope of these Procedures

Reference: [RA3.5.1](#)

RA3.5 is a procedure for verifying the quality of insulation installation and air leakage control used in low rise residential buildings. This procedure is to be followed by the insulation installer via CF2Rs and a qualified Home Energy Rating System (HERS) Rater must verify its conformance for meeting the requirements of Sections [150.1\(c\)](#), and [110.7](#) of the Standards via CF3R's. The procedure applies to wood and metal construction of framed and non-framed envelope assemblies.

**Framed assemblies** include wall stud cavities, roof/ceiling assemblies, and floors typically insulated with:

- Batts of mineral fiber and mineral wool;
- Loose-fill materials of mineral fiber, mineral wool, and cellulose;
- Spray polyurethane foam; and,
- Rigid board sheathing materials.

**Non-framed assemblies** include wall, roof/ceiling, and floors constructed of

- Structural insulated panels (SIP)\* and
- Insulated concrete forms (ICF)\*.

**Note 1:** This procedure applies to the entire thermal envelope of the building. In many instances, residential homes will use several types of insulation material, even in the same framed assembly. Each insulation material and the integrity of air leakage control for the building's entire thermal envelope must be verified by the HERS Rater for the home to comply with the Standards.

**Note 2:** Structural bracing, tie-downs, and framing of steel or specialized framing used to meet structural requirements of the California Building Code (CBC) are allowed. These areas shall be called out on the building plans with diagrams and/or specific design drawings indicating the R-value amount and fastening method to be used. All structural framing areas shall be insulated in a manner that resists thermal bridging from the outside to the inside of the assembly separating conditioned from unconditioned space. The insulation and air barrier integrity shall be verified by the HERS Rater.

\* Not covered in this guide because so few SIP's and ICF projects have been registered since the 2013 Energy Code went into effect (less than one half of one percent of all QII projects), we decided not to cover those insulation products in this document. They are not as prone to some of the most common installation issues and are covered well in sections [RA3.5.7](#) and [RA3.5.8](#).

### 3. Important Definitions

Reference: [RA3.5.2](#)

#### Continuous Air Barrier

A combination of interconnected materials and assemblies joined and sealed together to provide a continuous barrier to air leakage through the building envelope. The air barrier separates conditioned from unconditioned space, or adjoining conditioned spaces of different occupancies or uses. An air barrier is required in all thermal envelope assemblies to limit air movement between unconditioned/outside spaces and conditioned/inside spaces and must meet some very technical test requirements.

*Tip: The continuous air barrier will define the thermal boundary of a house. Designers and architects should decide very early in the design process **exactly** where the thermal boundary of a house is going to be. This seems trivial, but it really is not. Examples: bump-outs and fireplaces.*

If unsure of the materials, the completed building can be tested to demonstrate that the air leakage rate of the building envelope does not exceed 0.40 cfm/ft<sup>2</sup> at a pressure differential of 0.3 in w.g. (1.57 psf) (2.0 L/s.m<sup>2</sup> at 75 pa) in accordance with ASTM E779 or an equivalent approved method.

*Note that this allows non-tested materials to be used as long as the house passes a blower door test with a special target of 0.40 cfm<sup>75</sup> for every square foot of conditioned floor area. Example: a 2100 square foot home would have a target of 840 cfm at 75 Pa.*

Individual materials and assemblies of materials that can demonstrate compliance with the air barrier testing requirements must be installed according to the manufacturer's instructions and a HERS rater shall verify the integrity of the installation. Below are example materials meeting the air permeance testing performance levels above. Manufacturers of these and other product types must provide a specification or product data sheet showing compliance to the ASTM testing requirements to be considered as an air barrier.



**Note:**

- Fiberglass and cellulose insulation do not create an effective air barrier.
- Spray foam, when installed to the proper thickness can act as an effective air barrier.
- Rigid foam installed to the proper thickness and sealed per manufacturer's recommendations can act as an effective air barrier.

**Qualified Components of an Effective Air Barrier**

- Plywood - minimum 3/8 inch
- Oriented Strand Board - minimum 3/8 inches
- Particle Board - minimum 1/2 inch
- Exterior or Interior Gypsum Board (drywall) - minimum 1/2 inch
- Cement Board - minimum 1/2 inch
- Insulation Board (sealed at seams per Mfg. recommendations)
  - Extruded Polystyrene - minimum 1/2 inch
  - Foil-Back Polyisocyanurate - minimum 1/2 inch
  - Foil Backed Urethane Foam Insulation - minimum 1 inch
- Spray Polyurethane Foam (SPF)
  - Closed Cell SPF - minimum thickness of 2.0 inches\*
  - Open Cell SPF - minimum thickness of 5.5 inches\*

**(\* ) specific cavity fill requirements apply, see section 6.**

- Built up Roofing Membrane
- Modified Bituminous Roof Membrane
- Fully Adhered Single-ply Roof Membrane
- Portland Cement/Sand Parge, or Gypsum Plaster - minimum 5/8 inch
- Cast-in-Place and Precast Concrete
- Fully Grouted Concrete Block Masonry
- Sheet Steel or Aluminum

## Air-tight

Limiting the passage of air into or out of the building envelope or other assembly.

**Note:** Thermal envelope assemblies (such as wall assemblies) shall be built to minimize air movement. Air movement brings unconditioned air and moisture through or into the assembly. For these procedures, air-tight shall be defined as an assembly or air barrier with all openings caulked, or sealed with minimally expansive foam, or taping/sealing of adjoining surfaces of air barrier materials and assemblies.

**Note:** In general, the air barrier is formed by the subfloor (or slab), sheathing on exterior walls and the ceiling drywall. Rim joists on raised foundations and multi-story buildings, become a continuation of the adjacent wall assemblies. Additionally, vertical wall cavities (stud bays) should form a "substantially" air-tight cavity consisting of the exterior sheathing, interior drywall, top and bottom plates, and vertical studs.

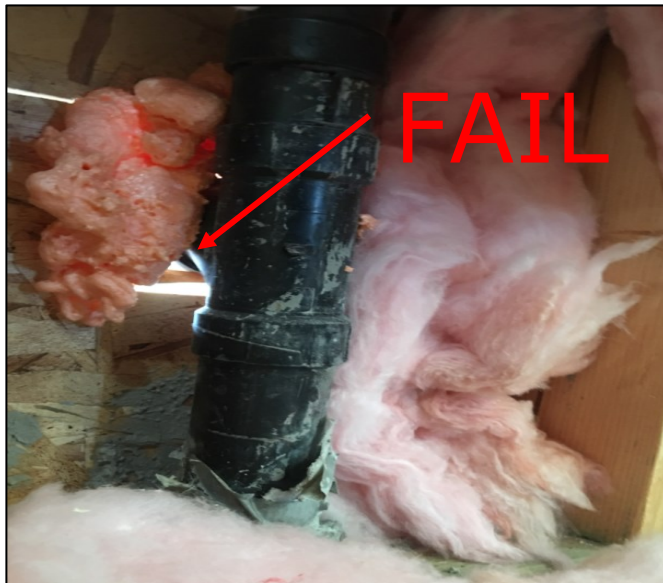

The photo shows a plumbing waste line clean out penetrating the exterior OSB. Spray foam was used to seal the gaps but much of it was missed. This is not acceptable and would fail QII.



This photo shows a poor job of spray foam being used to seal the bottom plate on a slab on grade application. This is not acceptable and would fail QII.

## Compression

The improper placement of insulation in an assembly that results in an installation less than the product's nominal thickness. Batt insulation should be fully "lofted" without compression, while loose fill and spray foam material should be properly applied as per the manufacturer's specified density to achieve its full R-value.

Limited compression is ONLY allowed at plumbing, vents, and other obstructions and in cavities of non-standard framing. **Compression of insulation in these situations is limited to no more than 30% of its nominal thickness.**

**Note:** The R-value is proportional to thickness and that compression does affect R-Value. You cannot cram an R-19 batt into a 2x4 wall and expect it to still be R-19. When the compression is more than 30% it begins to significantly affect the R-value per inch because the fibers are closer together and conduct heat better.

The chart below shows the importance of having no compression as the R-value drops the more you compress the insulation.

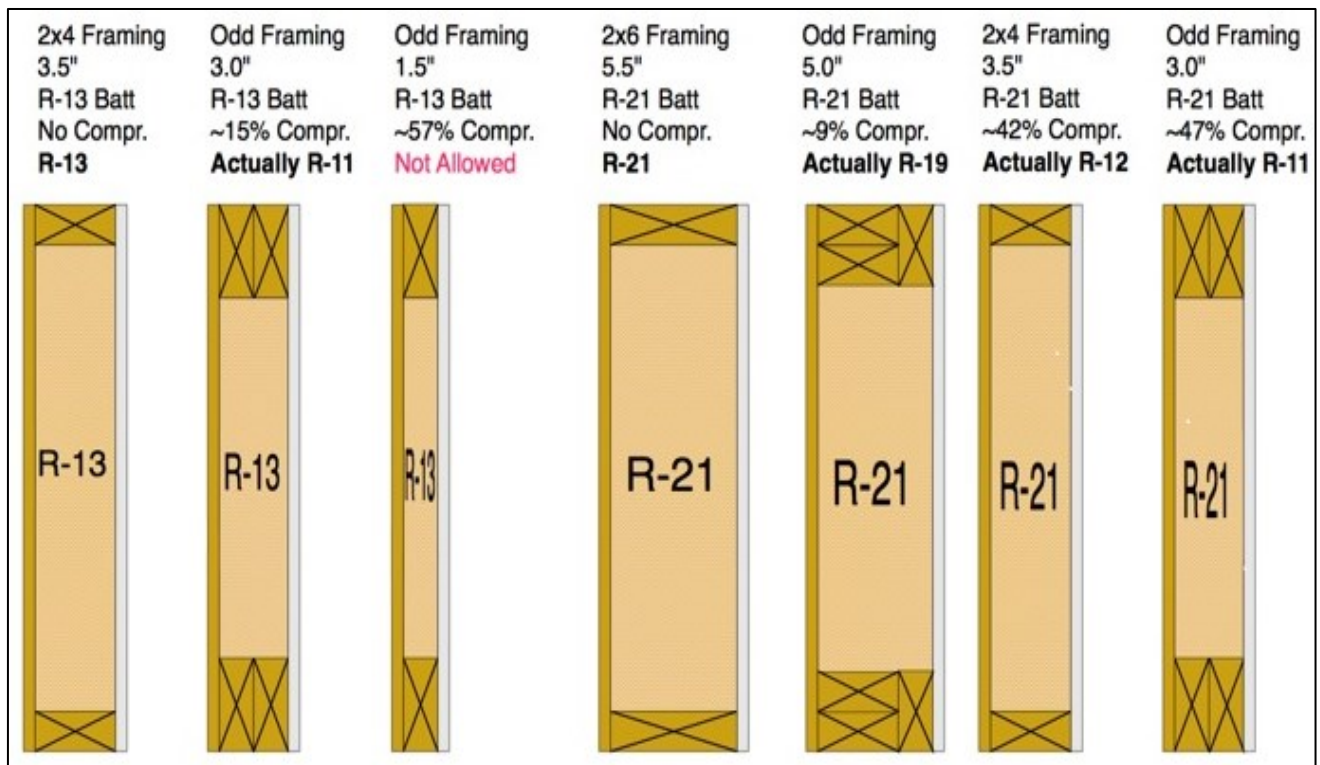

## Delaminated

Separation of the insulation's full thickness to facilitate its installation around or between obstructions. Batt and blanket insulation are often split or delaminated to fit around electrical wires and plumbing runs through a wall cavity to prevent voids or compression of the insulation. The delamination must ensure that the full thickness of the insulation is installed between the obstruction and the finish material covering the framing.



For example, a plumbing pipe located one-third of the distance from the front of the cavity should have batt insulation delaminated so that two-thirds of the batt is installed towards the outside wall surface and one-third is installed towards the inside wall surface from the pipe.

## Draft Stops

A construction material or device installed to prevent the movement of air within open spaces of concealed areas of building components, such as crawlspaces, floor/ceiling assemblies, wall assemblies, roof/ceiling assemblies, attics, and other interstitial cavities – meaning “spaces between.” Draft stops are typically constructed of dimensional lumber blocking, plywood or drywall. Draft stops become part of the attic or subfloor air barrier and shall be airtight.

**Note:** Draft stops are important components of the air barrier. Porous insulation materials such as fiberglass cannot serve as draft stops since they are not airtight.

The photo shows a draft stop cut from OSB to fit around two ducts going up through a large square chase. Notice the gap in the corners where air can leak through. These should be sealed with expansive foam or other approved material.





SPF can serve as a draft stop as long as it meets the minimum thickness required to be an air barrier. Specifications of SPF being used as an air barrier will be discussed later in this manual.

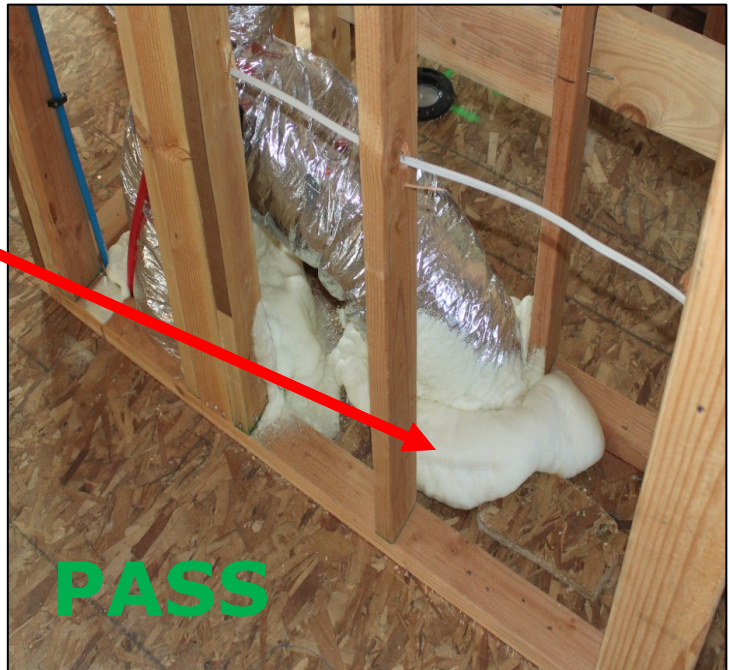

## Friction Fit

A means of installing insulation within the framed cavity without the use of mechanical fasteners such that the material's full thickness in all directions is sufficient to keep the material in its intended position.

In reference to batt insulation, friction fit batts have enough side-to-side force, due to the loft of the insulation material, to hold the batt in place by friction without use of mechanical fasteners. Loft of insulation material refers to the nominal, un-compressed thickness of the product. Friction fitting of batt and blanket insulation is allowed provided the insulation can be uniformly installed without excessive compression, voids or gaps.

**Note:** Friction fitting of faced batt and blanket insulation, with or without an attachment flange, is allowed provided the insulation's installation integrity can be maintained.



### Gaps

Uninsulated areas at the edge of insulation materials where insulation is not in contact with framing members or other materials at the edge of the insulation. Gaps occur when insulation length or width is too short or narrow for the cavity. Gaps also result when insulation is force fitted into a cavity instead of being cut to fit.

**Note:** Gaps in insulation are avoidable and are not permitted.

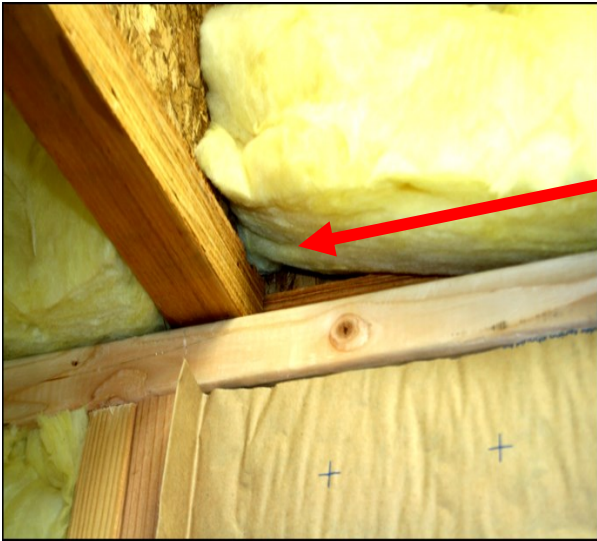

**FAIL**



**FAIL**



## Hard Covers

Building materials, such as plywood or gypsum board (drywall) which become part of the ceiling air barrier. Hard covers shall be installed above areas where there is a drop ceiling or soffit. Hard covers become part of the ceiling air barrier and shall be airtight. For example, a home with 10-foot ceilings may have an entry closet with a ceiling lowered to 8 feet. In this case, a hard cover is installed at the 10-foot level above the entry closet.

### The Importance of Hard Covers

The first photo shows a typical dropped soffit inside a house that separates the kitchen from the family room. The second and third photos are from the attic looking down into this dropped soffit. You can see how the loose fill insulation has fallen down into the dropped area. This results in the upper portion of the dropped area being uninsulated. The diagram shows how a correctly installed hard cover would have prevented this.

Completely filling the dropped area with insulation is an inferior alternative. It creates substantially more surface area through which heat can conduct, plus the extra insulation needed is rarely accounted for and ends up stealing insulation from the rest of the attic.

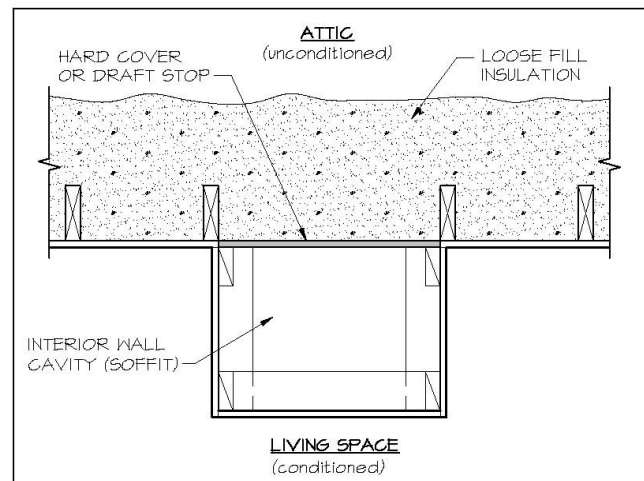
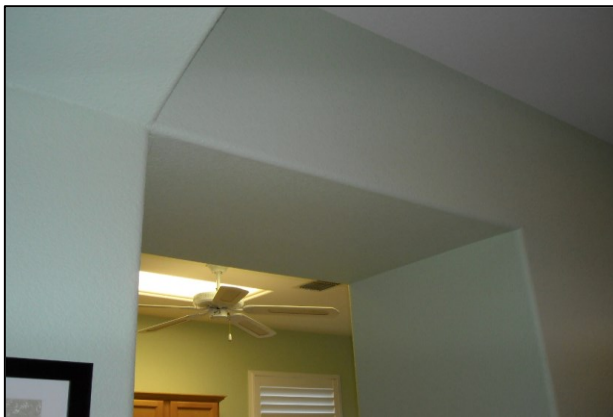



### Attic

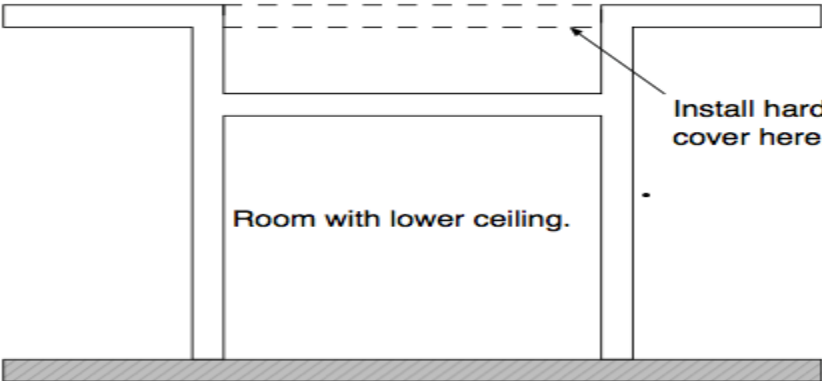

Uninsulated

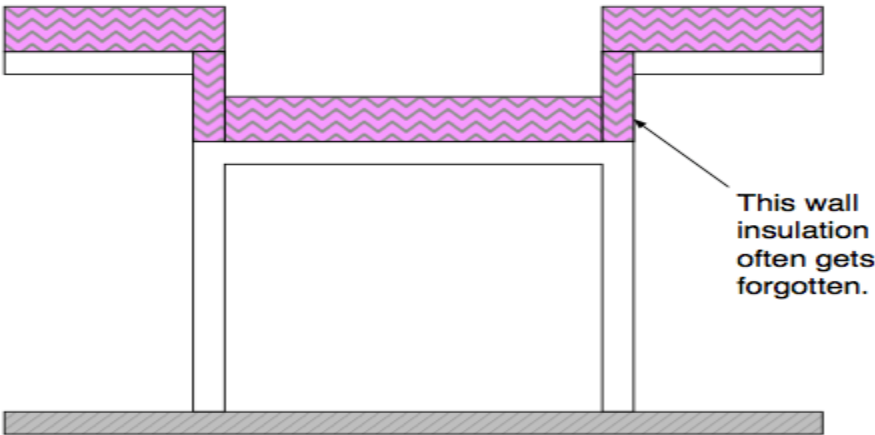

Typical

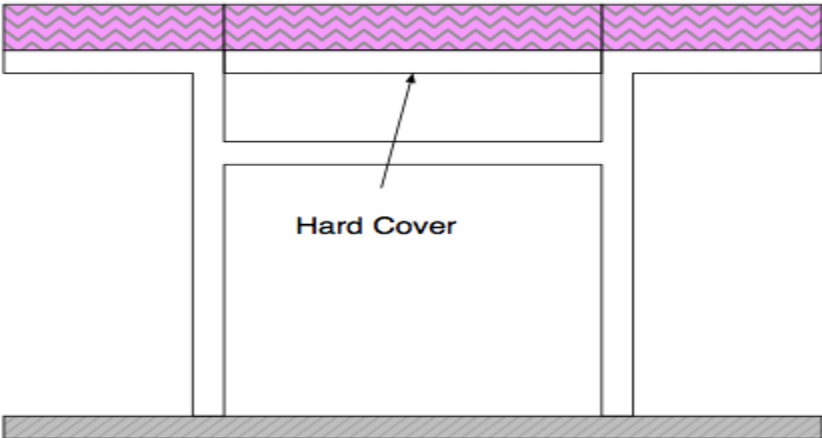

Best Practice

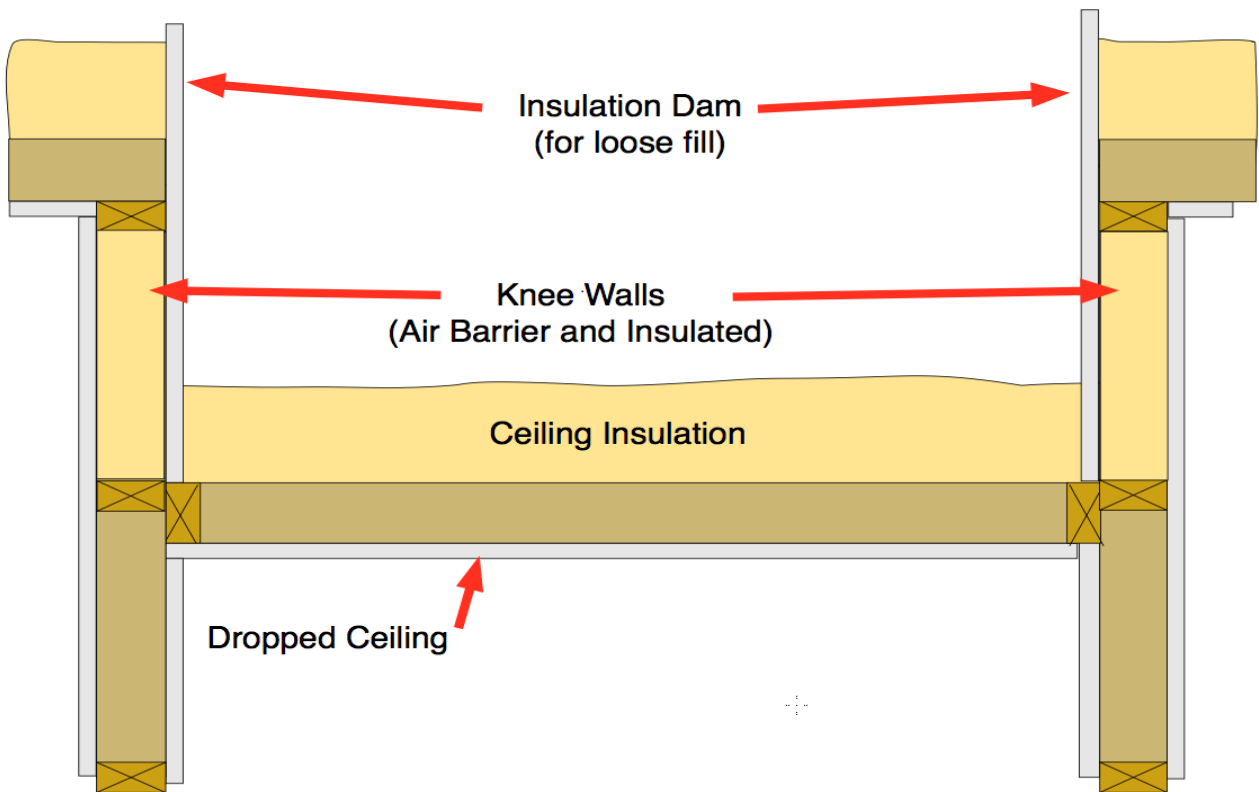
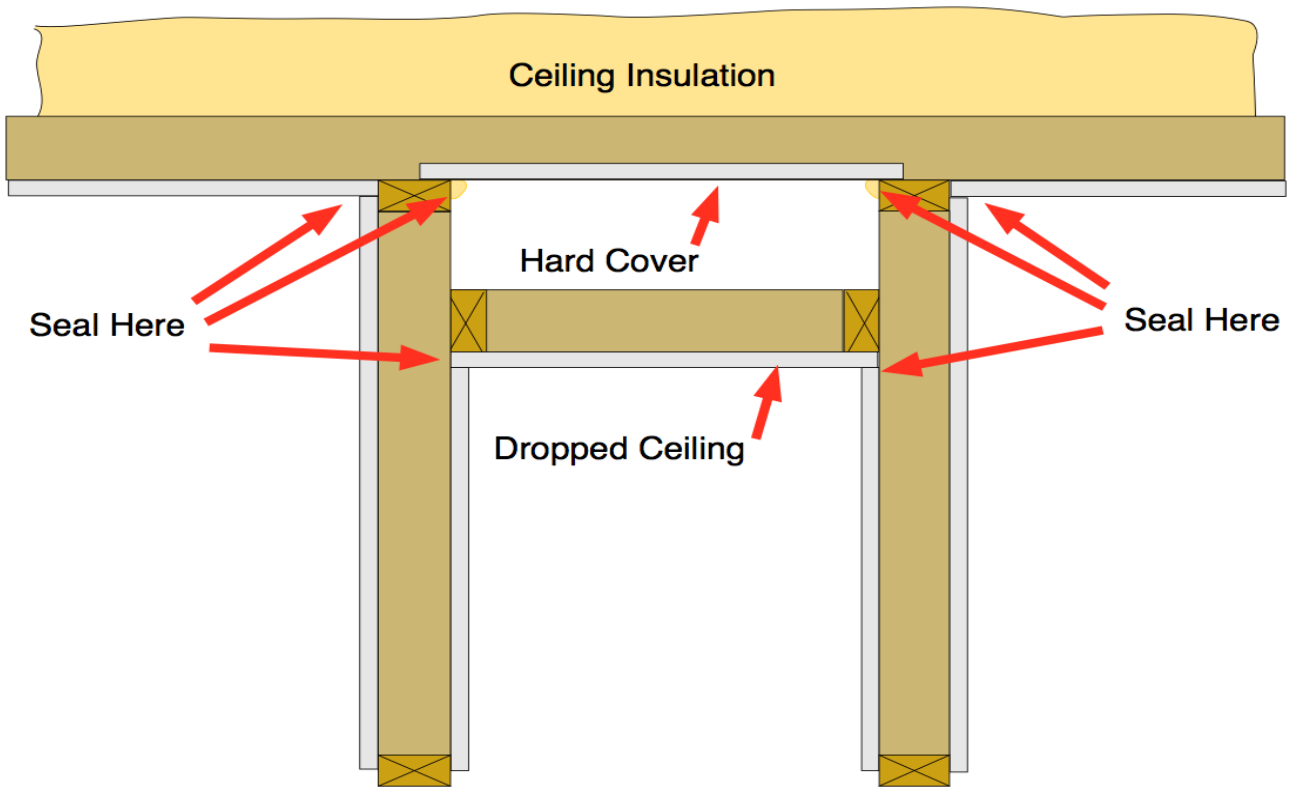

## Inset Stapling

A method of attaching faced batt or blanket insulation to wood framing. The flange of the insulation facing is pushed inside the face of the framing member and stapled as opposed to stapling over the face of the studs, which can interfere with the gypboard. In windy areas installers often staple the flanges of faced batts to the sides of the stud in order to assure that the insulation remains in place until covered with drywall, particularly on the wall between the house and the garage where there isn't any exterior sheathing to help keep the insulation in place.

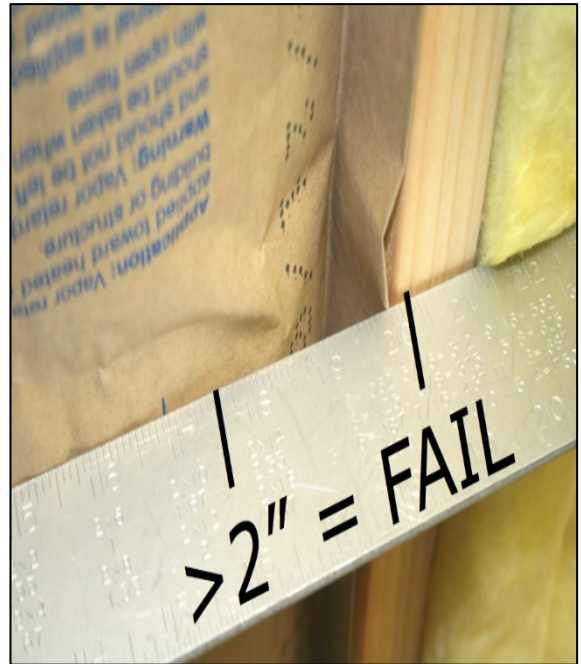

**Note:** Voids created by the flange inset which do not extend more than two inches from the stud on each side shall be allowed.

## Minimally Expansive Foam

A single-component polyurethane foam system typically formulated in a handheld can or portable container to seal and fill construction gaps and crevasses, holes, and cracks without distorting adjacent framing or fenestration.

These materials are not used for insulating purposes, rather as agents for air sealing of gaps and crevasses that are too small to be insulated.

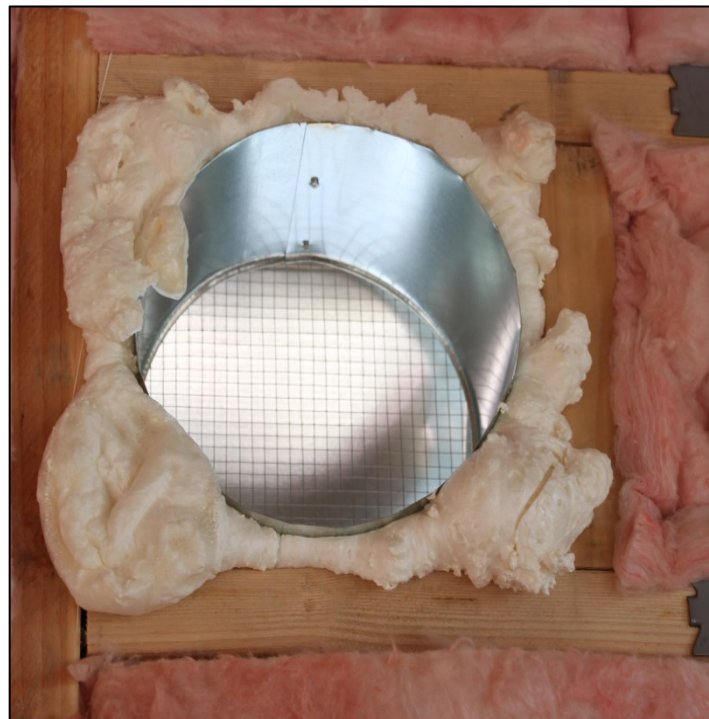

## Net Free Area (NFA)

The net free-area of a vent cover is equal to the total vent opening less the interference to air flow caused by a screen or louver used for ventilation. Screened or louvered vent opening covers are typically marked by the manufacturer with the "net free-area." For example, a 22.5 in. by 3.5 in. eave vent screen with a total area of 78.75 square inches may have a net free-area of only 45 square inches.

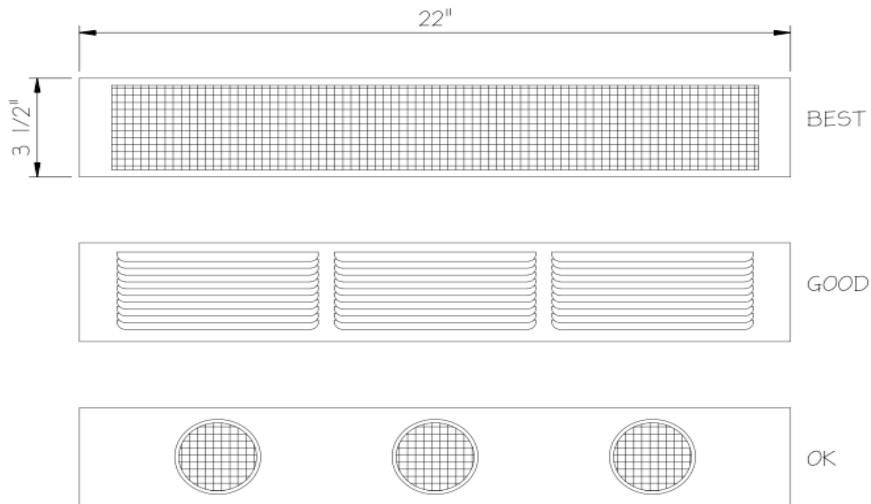

### The Importance of Attic Ventilation

A great deal of research has gone into the benefits of preventing heat buildup in attics in the summer, especially given that ducts are often located in the attic. The energy code encourages radiant barrier, insulation at the roof deck of a vented attic, and some means of mechanically ventilating an attic, such as whole house fans.

One of the most effective tools for removing heat from an attic is passive attic vents. Poor attic ventilation alone has been known to cause air conditioners to run at night even when it is cool outside, due to the trapped heat in the attic. There are a variety of types of vents: gable end, eyebrow, dormer, cloaked dormer and eave vents, and the latter being the most common, but also the most likely to be affected by improper installation of ceiling insulation and poor framing practices. It's not uncommon to look into a screened eave vent (top example above) and see nothing but insulation. While insulation is very poor at stopping airflow into or out of a house, it can be quite effective at reducing attic air movement.

HERS Raters will check to make sure that the required vent area is unobstructed all the way to the main volume of the attic. Obstructions by framing or improperly baffled insulation will result in a failed inspection. Designers are encouraged to install more ventilation than is allowed by code. The code minimum is actually not intended for the heat removal that we desire. More is generally better.

## Baffle, Eave Vent

Material such as cardboard or foam attached to the roof rafters to maintain an air-space against the roof deck to allow attic ventilation air to move up from the eave vents without washing through adjacent insulation.

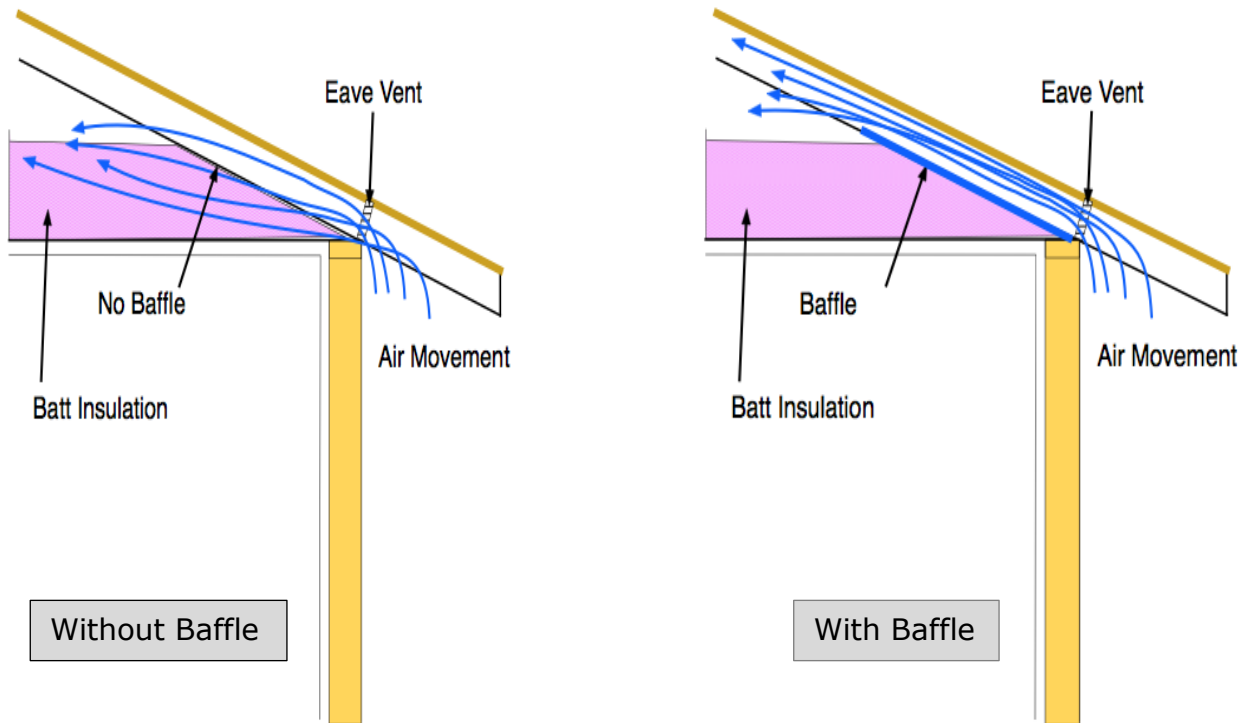

**Note:** Baffles which maintain the net free area are required at all eave vents to prevent air movement under or into the adjacent insulation. Additionally, insulation must be installed to the outside edge of the exterior top plate. Raters shall verify that the baffles maintain the net free area. The open area created by the baffle should be roughly equivalent to the area of the eave vent.



## Voids and Air Spaces

An uninsulated space within an enclosed building assembly created when insulation does not fully fill the framed cavity. The result is an air space or void between the insulation surface and the assembly's air barrier. Voids are not allowed.

**Note:** Voids occur when insulation depth is too shallow for the insulation to maintain contact with the air barrier or when batt insulation has been pushed too far into a cavity.

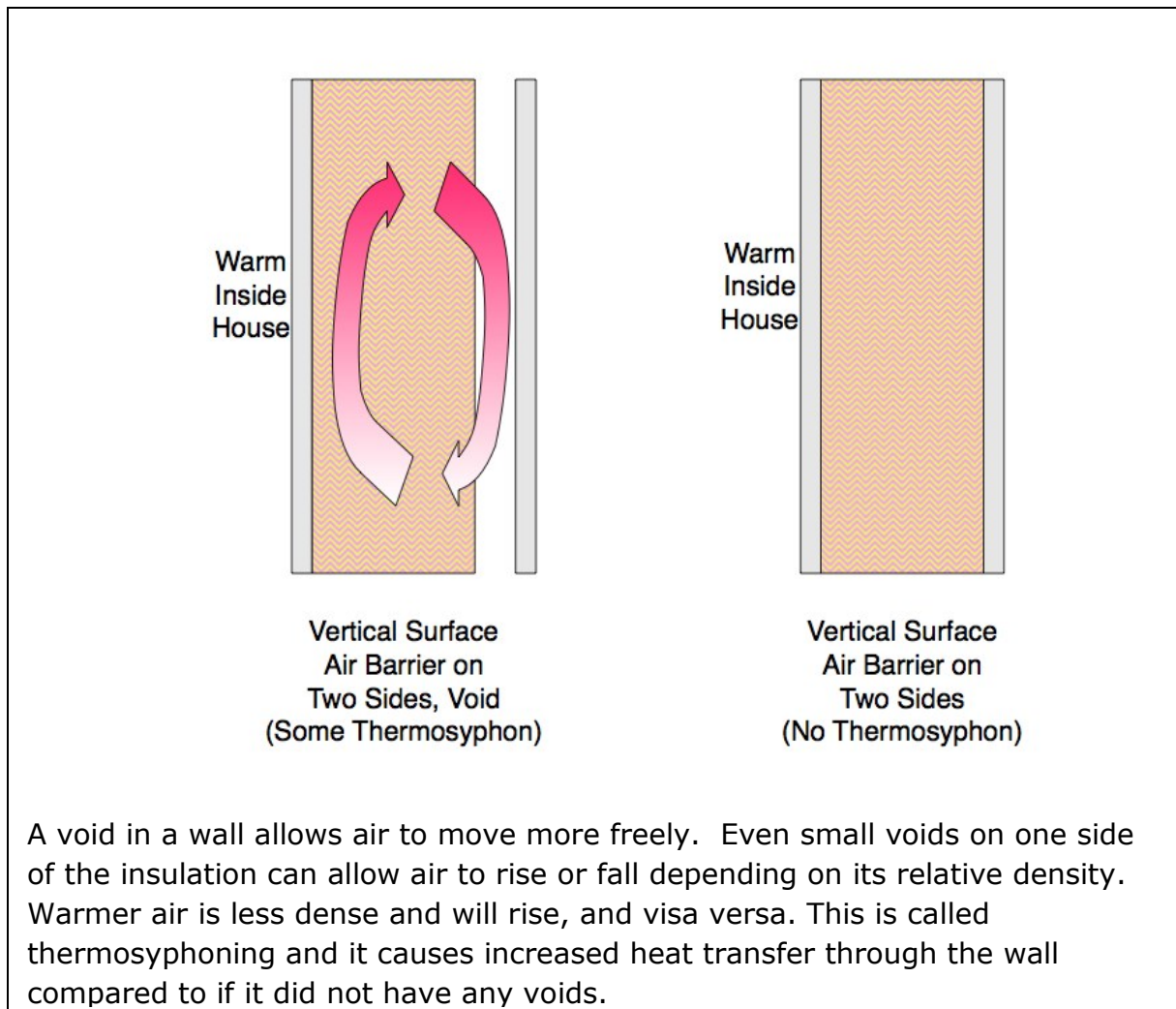
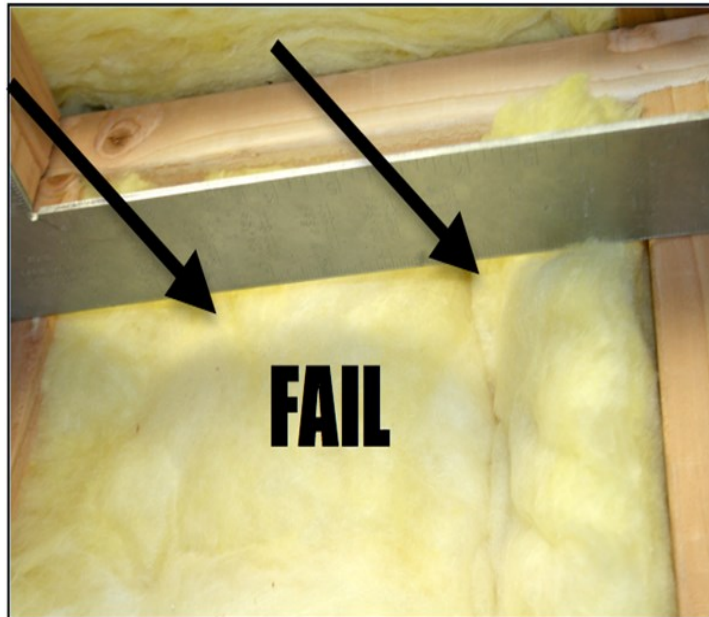



## 4. Importance of Defining the Thermal Boundary

Coordination between trades is critical, as is the need for the designer of the house to really plan ahead on what exactly constitutes the thermal boundary. It can help to think of the thermal boundary as having two sides, an interior side and an exterior side. For ceilings, roofs, and rim joists, only one side needs to be in contact with an air barrier. With walls, **both** the interior and exterior surfaces need to be in *continuous* contact with the air barrier

Consider the schematic section of this house:

It has two stories, an attached garage with attic above, a vented unconditioned attic above living space, a vented unconditioned crawlspace, and a fiberglass shower insert against an exterior wall (in this case a knee wall).

The interior and exterior surfaces of the conditioned boundaries are shown here in red.

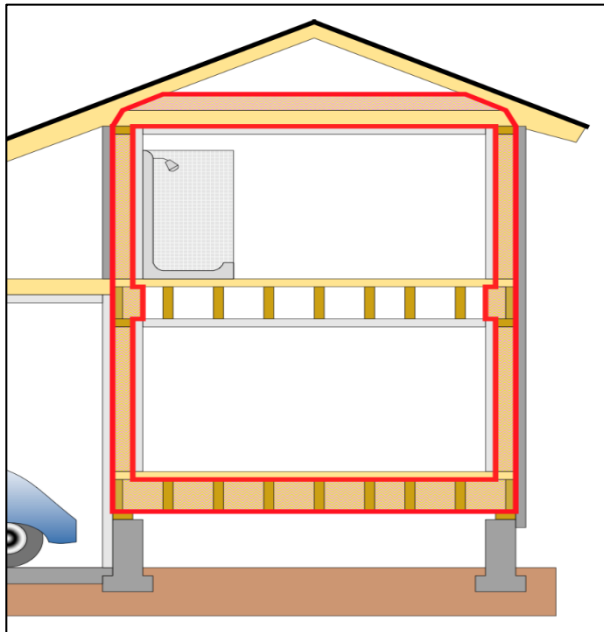
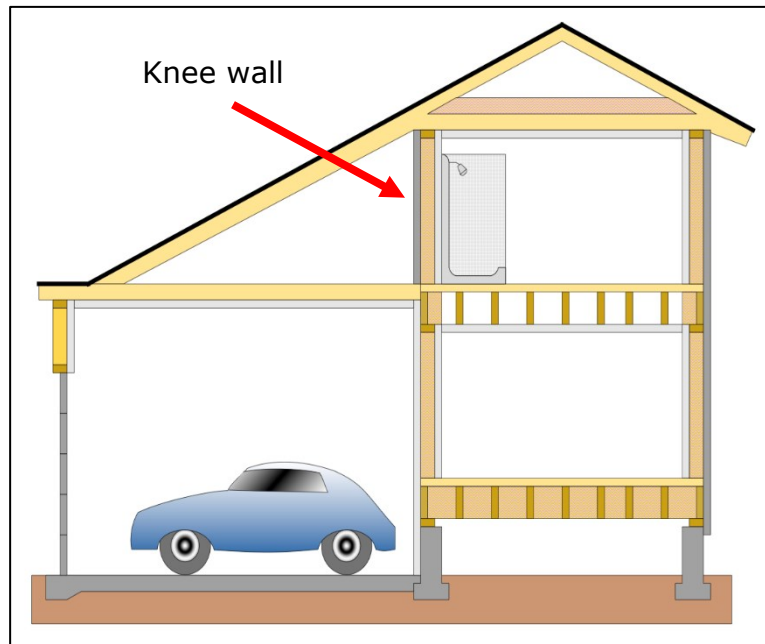

Notice the **air barrier** must be continuous, without any breaks or interruptions where air could readily pass between conditioned and unconditioned spaces. The entire boundary is also properly insulated, except at normal framing members. These should be minimized where possible.

If the home had an unvented, conditioned attic, with insulation under the roof deck the conditioned boundary would be substantially different.

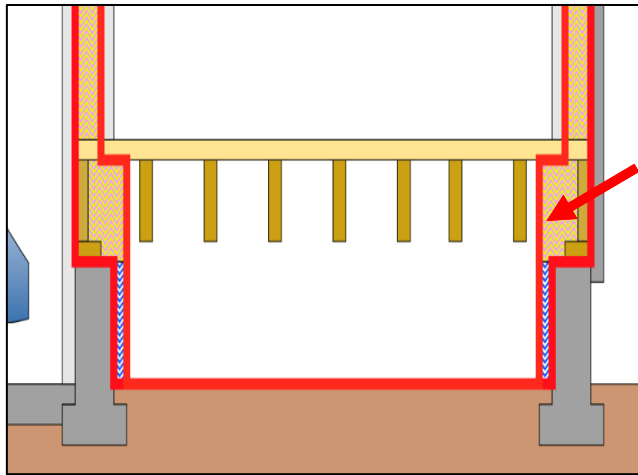
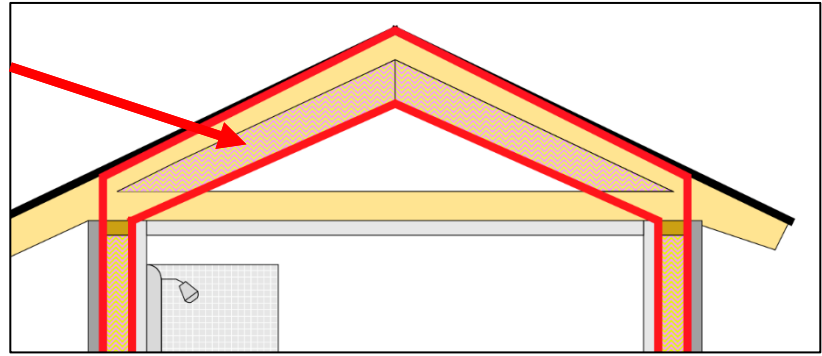

Similarly, if the home had an unvented, conditioned crawlspace, with insulation at the foundation walls, the conditioned boundary would again be substantially different. Conditioned crawlspaces also require a plastic vapor barrier over any bare dirt.

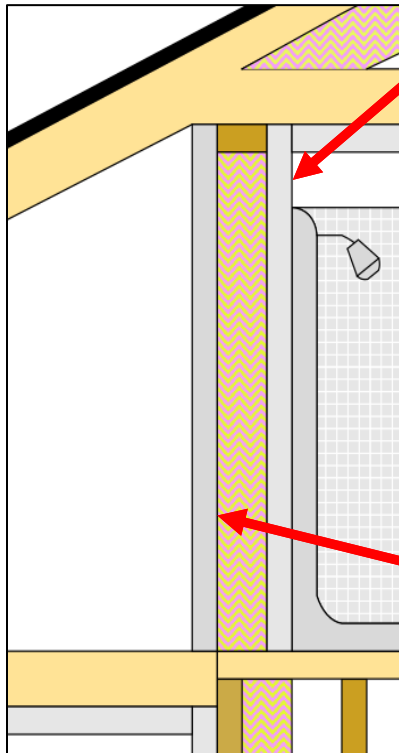

Note that the shower insert has an air barrier installed behind it. This is required by QII.

If there is no air barrier behind the shower, the interior surface of the air barrier would be the backside of the fiberglass shower insert. This would not meet the QII protocols.

Also note that there is an air barrier on the attic side of the knee wall. This can be a particular challenge that requires extra coordination.

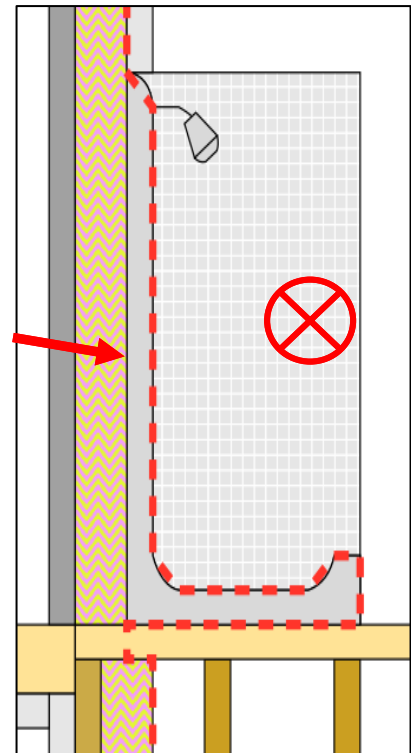

Frequently encountered challenges are exterior pop-outs for fireplaces. Historically, these have been treated like this, with the wall insulation stopping at the edge of the fireplace.

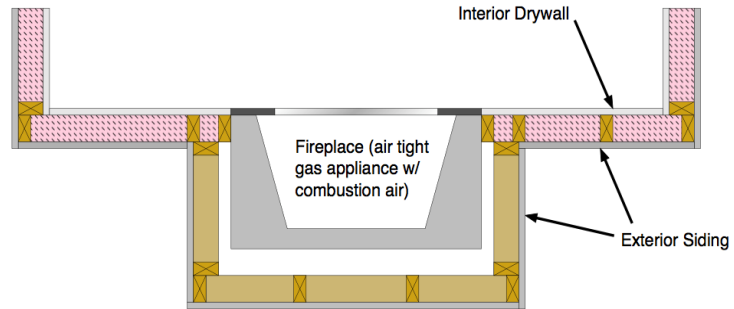

However, this is not acceptable practice to meet QII because it results in an inadequate thermal boundary.

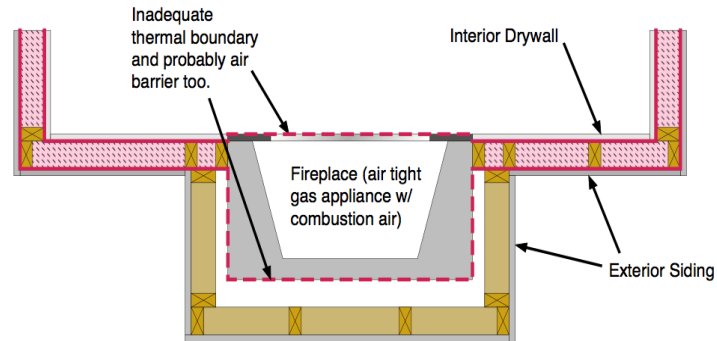

This approach would meet QII:

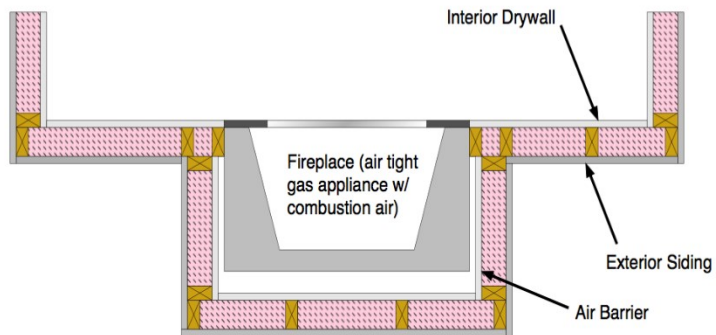

Note that at some point the pop-out will have a top, which must also be insulated. The flue will need to have an air tight flashing around it.

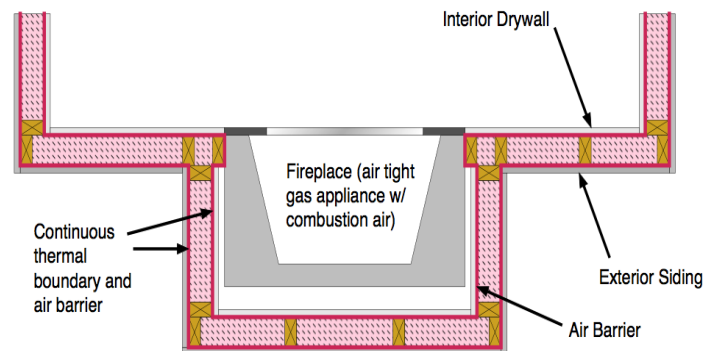

## 5. Inspection - Air Barrier

Air sealing begins as each successive layer of a building is assembled. The air barrier must be continuous and is constructed of multiple building components, enclosing all of the conditioned space. In many cases the installed drywall forms most of a building's air barrier. The subfloor or slab foundation is another major component of the air barrier. How those components are finished or connected using tapes, mastic, gaskets, caulk, foam or other products is essential to the integrity of the air barrier.

Visualizing the air barrier, particularly the continuity of the air barrier, becomes increasingly difficult as the building shell deviates from the shape of a box! Of particular interest to a during a QII verification are changes in plate height, drop ceilings, soffits, knee walls, mechanical chases, chimneys, plumbing/wiring, cantilevered building assemblies, attached garages and other assemblies.

## Floors

The bottom plates of wall assemblies shall be sealed to the stem wall or slab foundation typically with a foam gasket, caulk, or spray foam. If caulk or spray foam is being used, it should be on one side or the other so it can be visually verified. This is typically done with spray foam on the interior of the assembly.



***Illustration: Slab on grade***

This diagram is a side view of a wall assembly showing the sill plate sealed to the slab foundation. If caulking is used, it must be on one side or the other in order to verify that it is sealed.

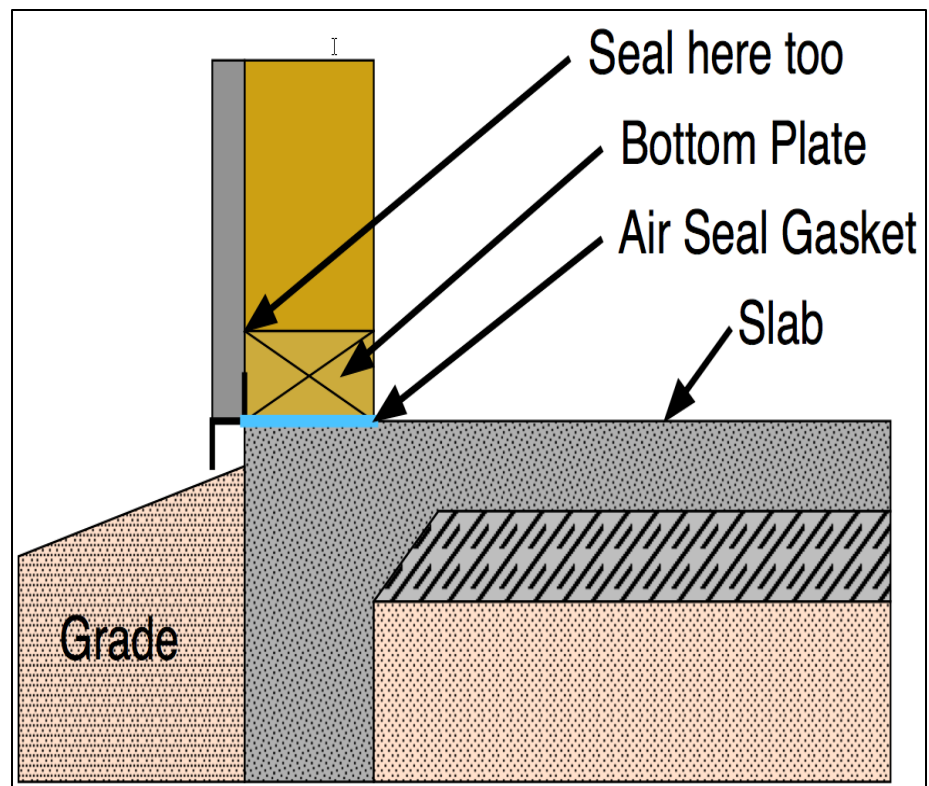



### ***Illustration: Raised Foundation***

This diagram is a side view of a wall assembly showing the sill plate sealed to the stem wall on a raised foundation. If caulking is used, it must be on one side or the other in order to verify that it is sealed.

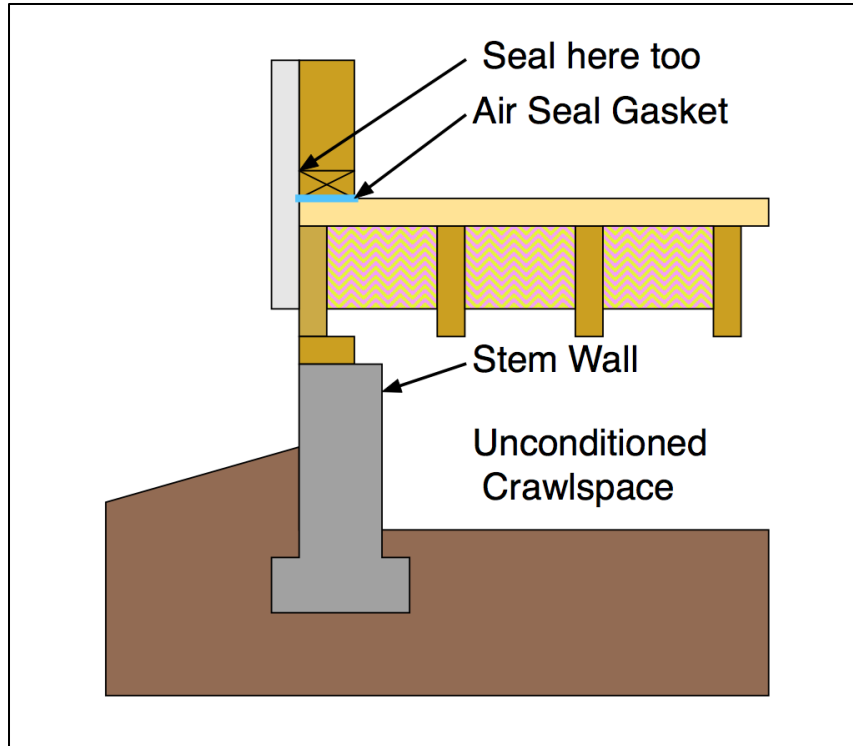

All plumbing, wiring or other penetrations through the subfloor and bottom plates, into the crawlspace or between floors shall be sealed with caulking or spray foam.

Plumbing vent pipe penetration in bottom plate is sealed with spray foam.



Plumbing access holes cut into the subfloor to set tubs and showers shall be sealed with a hard cover and caulk or spray foam.

If there are any chases into the crawlspace, those chases need to be sealed with a draft stop and caulk or foam at every floor and ceiling plate level they pass through.

Draft stop is typically made from OSB and sealed with spray foam.





## Ceiling

Since drywall can be a major component in the building's air barrier, penetrations through the ceiling drywall and top plates shall be sealed using either spray foam or caulking. Below are some common top plate penetrations that need to be sealed.

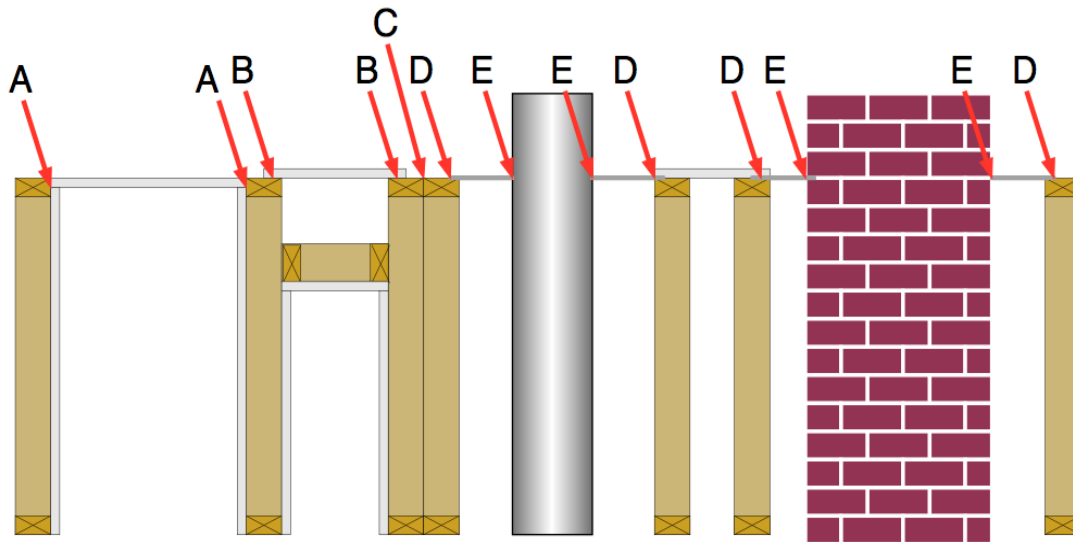

There must be a continuous air barrier at the ceiling level when there is unconditioned space above. Best practice is to also do this when there is a floor above.

- A. Seal where the sheet rock on the wall meets the top plate.
- B. Seal all hard covers to top plate.
- C. Seal any gaps between adjacent top plates of double walls.
- D. Seal metal flashing to top plates.
- E. Seal metal flashing to flues or chimneys with fire caulking as required by fire code. For flue vents, special clearances to combustibles do apply. Code requires a 1" clearance for double wall "B vent" and 6" clearance for single wall flue pipes. See page 33 for a detail on how flashing is installed around flue pipes so the insulation can be installed to full depth around the flue and still maintain proper clearances.

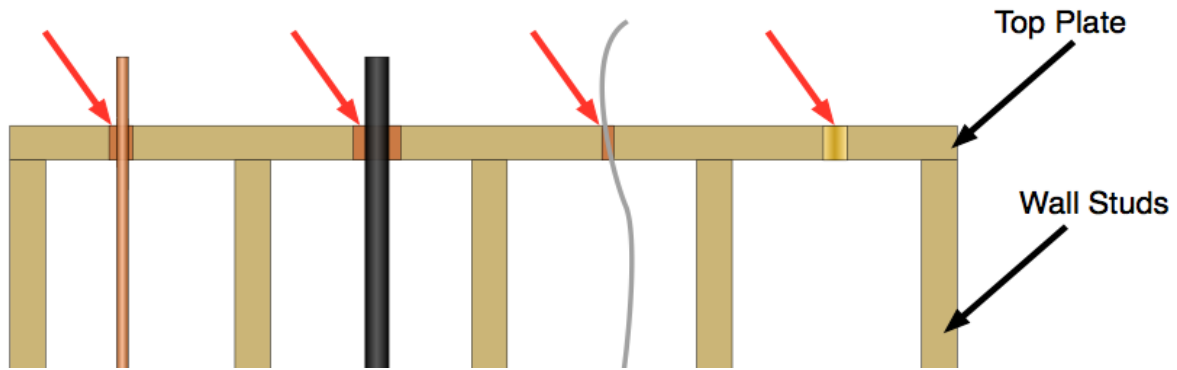

QII protocols require that the HERS Rater verifies that each ceiling penetration is gasketed, caulked, foamed, taped or otherwise sealed as applicable. The following are typical ceiling penetrations that must be sealed and HERS verified.

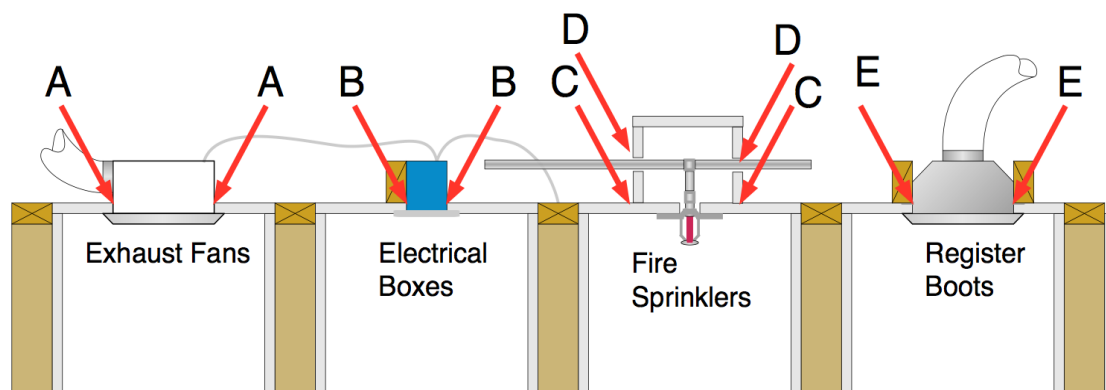

Seal all penetrations to the ceiling drywall when there is unconditioned space above. Best practice is to also do this when there is a floor above.

- A. Seal exhaust fan housing to drywall.
- B. Seal all electrical boxes that penetrate drywall to drywall.
- C. Seal all fire sprinklers to drywall.
- D. If sprinkler manufacturer does not allow sealing around the sprinkler head, an air tight box can be built over sprinkler. All penetrations in the box must be sealed as well as where box meets drywall.
- E. Seal around all HVAC supply and return register boots.

## Recessed Can Lighting

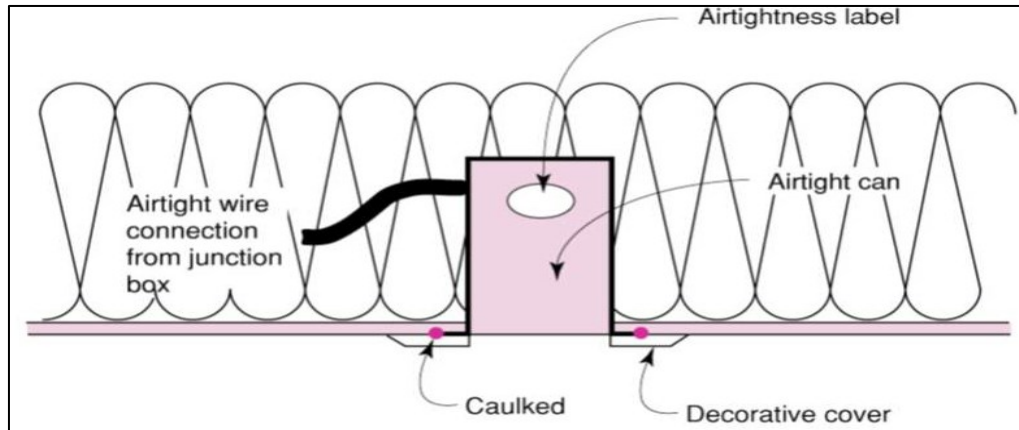

Insulation Contact/ Air Tight (IC/AT) rated can light



Can lighting typically comes with a foam gasket for sealing the can light to the drywall. Raters must ensure that these are present. If they are not present then caulking or spray foam is adequate.



Raters need to also ensure that the recessed can lights are rated for insulation contact and are air tight (IC/AT rated).

## Exhaust Ventilators

Exhaust fan housing shall be sealed to the surrounding drywall to prevent leakage.

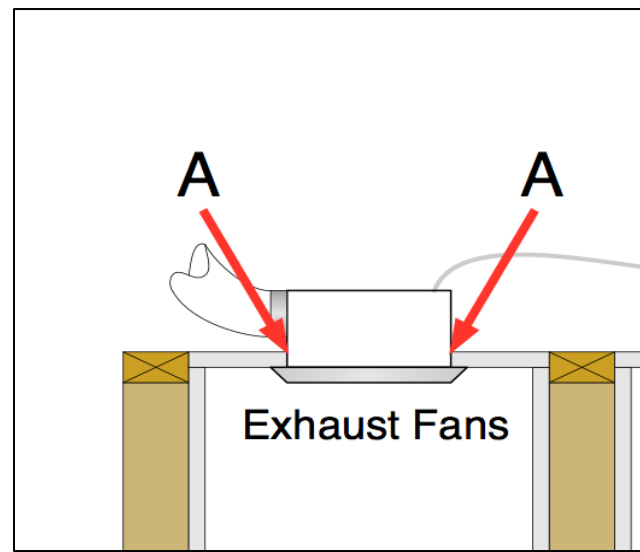

## Electrical Boxes

Verify that all electrical boxes that penetrate drywall from unconditioned spaces to conditioned space are sealed with applicable sealing products.

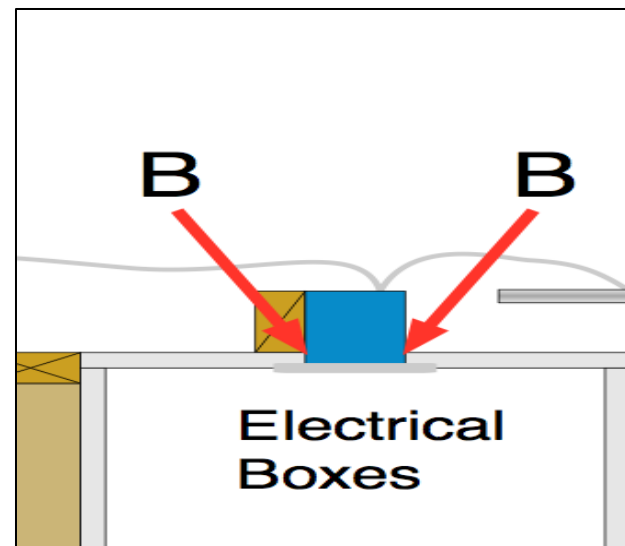

## Fire Sprinklers

Verify that fire sprinklers are sealed to drywall. Some manufacturers may require special attention on how fire sprinklers may be sealed. If in doubt, always check the manufacturer's specifications.

If sprinkler manufacturer does not allow sealing around the sprinkler head, an air tight box may need to be built over sprinkler. All penetrations in the box must be sealed as well as where box meets drywall. **Always check with the sprinkler manufacturer first.**

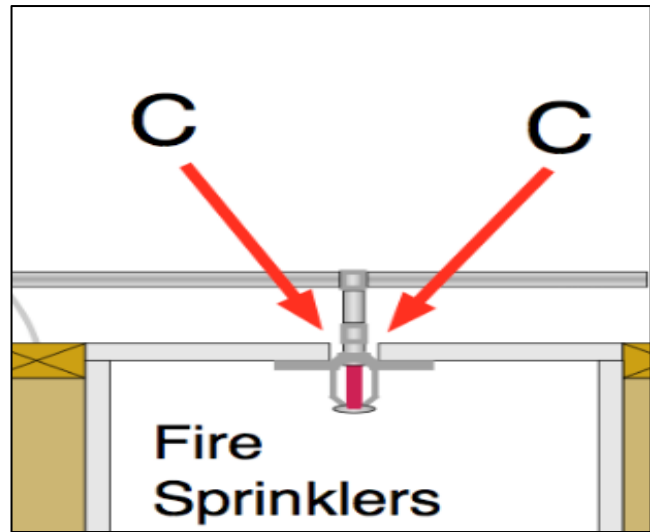

## HVAC Register Boots

HVAC register boots are to be sealed to the surrounding drywall or subfloor to prevent leakage.

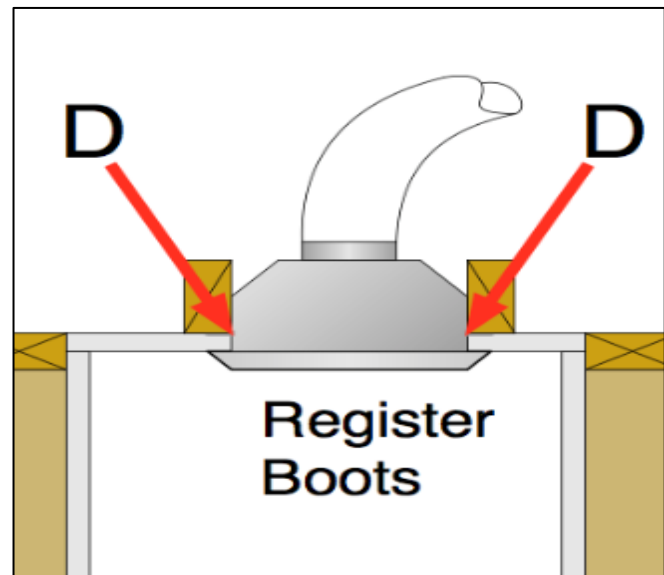



## Flue Pipes

Where flue pipes penetrate the ceiling, it is important to have clearances to combustibles. In the photo Class B vent is used which requires a 1-inch clearance to the surrounding material. If single wall flue pipe is used then 6 inches would be required. Here the base flashing is cut to fit around the pipe to help maintain that 1-inch clearance. The base flashing is sealed with high temperature caulking to prevent leakage.



Once the base flashing is cut, sealed and secure, high temperature caulking is used to seal between the flue pipe and the base flashing.

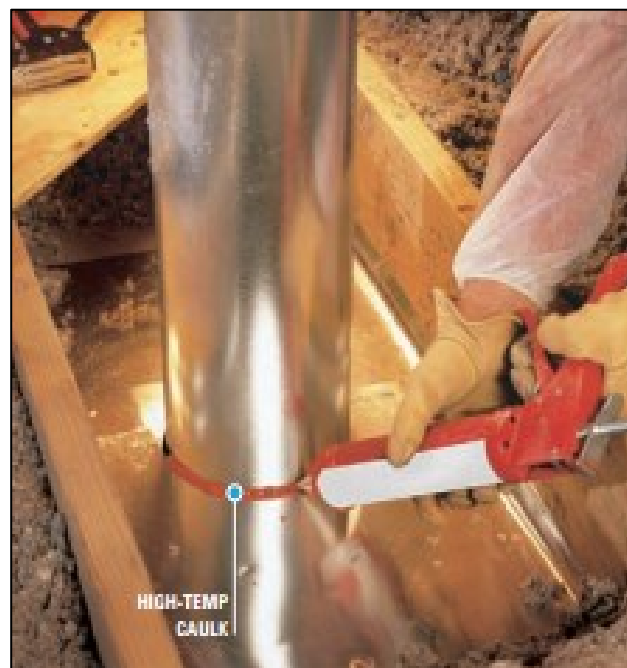

Lastly, a sheet metal dam is fabricated to wrap the flue pipe. Tabs are bent in at the top of the dam to help maintain the 1-inch clearance between the flue pipe and the sheet metal as insulation will be in contact with the sheet metal. At the bottom, tabs are bent out in order to secure the dam to the base flashing. The dam height needs to be high enough to be above the depth of the insulation required.



## Attic Access Hatch

The bottom of the attic access shall be gasketed to prevent air leakage of conditioned air to the unconditioned attic.

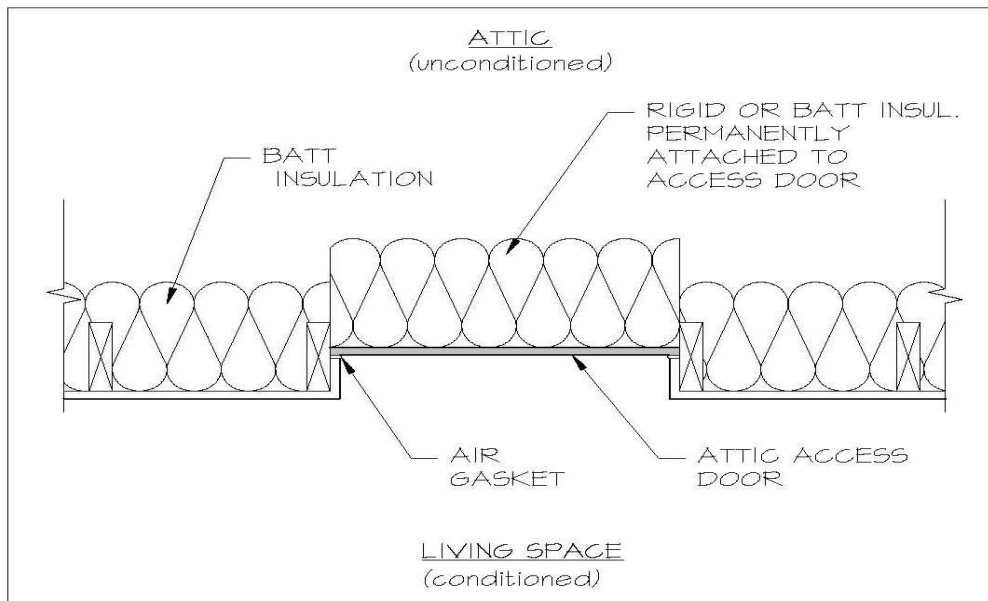

This diagram shows an attic ladder. In this application, weather stripping should be applied to the access door to prevent leakage. The insulation above the access door needs to be insulated to the same R-value as the attic.

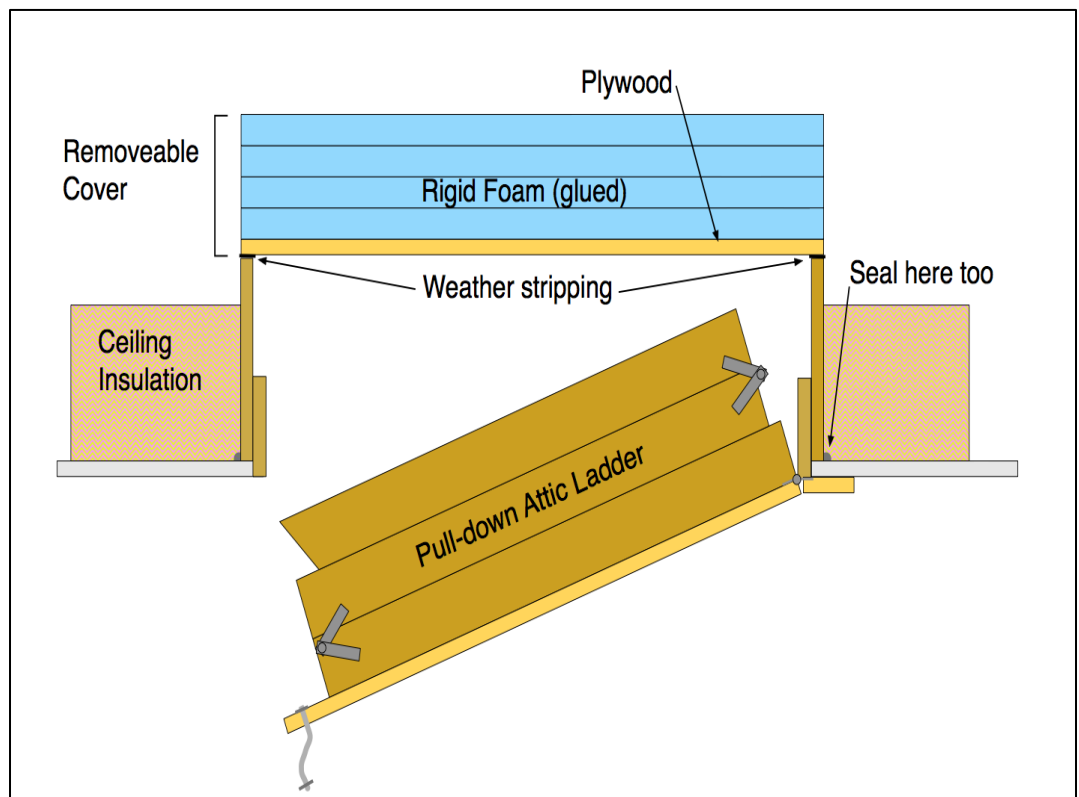

## Wall Cavities

Wall cavities/stud bays have additional air sealing requirements. To render an airtight cavity, builders must seal all gaps, seams or penetrations in exterior wall cavities with caulk, foam or other applicable sealing products.

This diagram shows the exterior sheathing sealed to the bottom plate and the bottom plate sealed to the slab foundation. The sheathing is typically sealed from the inside of the stud bay after the sheathing is installed (See figure 1 next page). The bottom plate typically has a foam gasket installed between the bottom plate and foundation but caulking is acceptable as well.

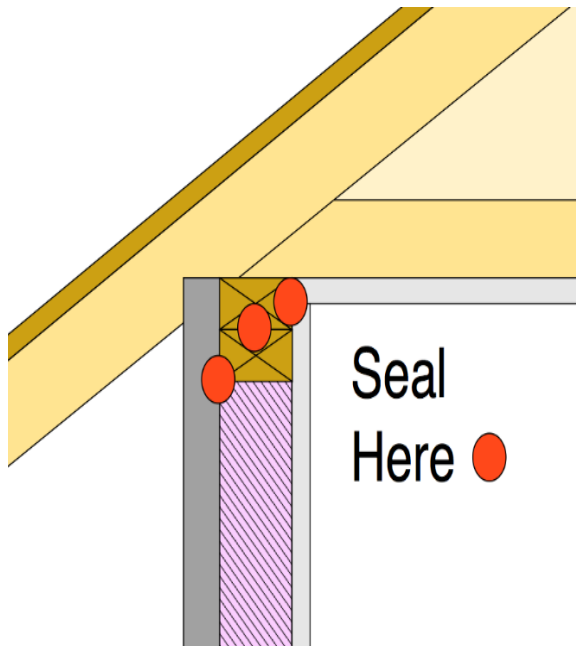
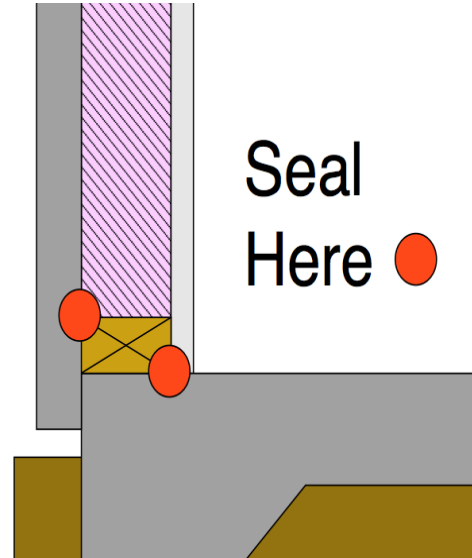

This diagram shows the exterior sheathing sealed to the double top plate. The gap between the double top plates is also sealed to prevent air movement, this is typically done on the interior after framing is completed (See figure 1). The interior drywall is also sealed on all exterior and interior walls. This is typically done using a foam gasket that is stapled to the top plate after framing and before drywall installation. Raters should ensure that the foam gasket is continuous and intact around all top plates (See figure 2).

Figure 1 below shows an alternative when sealing top and bottom plates to the exterior plywood or OSB. In this photo a spray applied caulking is used as an air sealer. When this product is used as in this example, the seams of the exterior plywood or OSB would not need to be taped or sealed on the exterior as long as the sealant completely goes around each stud on the top and bottom plate and each vertical stud that has an exterior plywood seam.

**Figure 1**

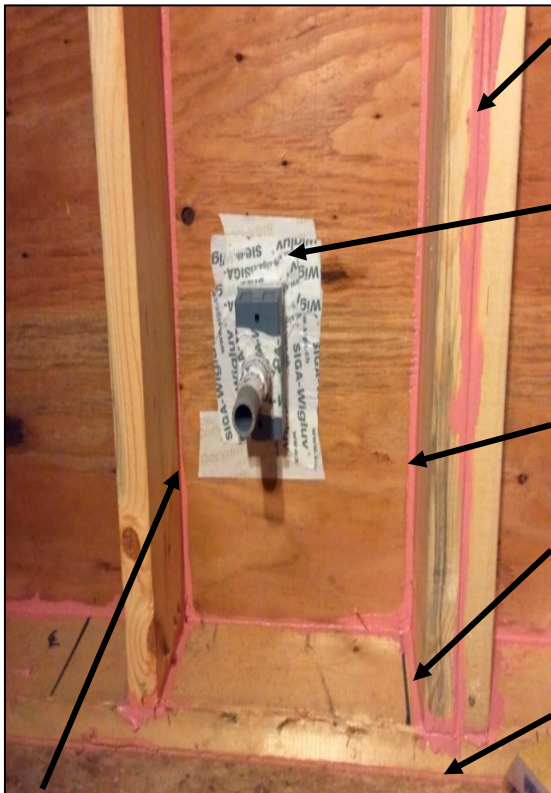

All seams and gaps at all joints are sealed. Here there is a doubled-up stud with an exterior seam in the plywood.

All exterior penetrations are sealed. Here a high-performance tape (Siga Wigluv) is used to seal an electrical penetration on an exterior wall, spray foam or caulking is also acceptable.

Sealant only needs to be applied to vertical studs where exterior plywood seams exist.

If sealing on the interior, studs at the top and bottom plates should be sealed around each stud.

The bottom plate in this photo is sealed with a spray applied sealant instead of using a foam gasket.

The vertical stud shown here does not need to be sealed vertically as there is no seam on the exterior plywood. They simply went the extra mile in creating each individual bay airtight.



All top plates on the inside of the building for interior and exterior walls shall be sealed to the attached ceiling drywall. More often than not, installers are using a product called sill seal. This is a foam gasket that can be stapled to the top plate after framing and before sheetrock is installed (see figure 2). This makes it much easier for the HERS Rater to verify that the top plates are sealed to the interior drywall. If this is done you have to ensure that the sealant goes around each vertical stud as shown in figure 1. Another method would be to seal the top plate from the attic side as shown in figure 3 on the next page.

**Figure 2**

This photo shows a foam gasket used to seal the top plate to the drywall. This is much more effective since the HERS Rater cannot verify caulking behind the drywall. It is also acceptable to seal the top plate in the attic after drywall is installed (See figure 3). This is not as common as a foam gasket because sealing plates on exterior walls at the eaves edge can be more difficult to access due to limited head room.



**CAUTION:** It has been recognized that drywall installers tend to remove this type of air sealing product as it may slightly interfere with installing drywall to the ceiling. Installers and builders should ensure this is left as is after an inspection. This could lead to multiple small leaks along the top plate of all interior and exterior walls.

**Figure 3**

Another option to seal the top plate of all interior or exterior walls, the top plates would need to be sealed after drywall was installed. Air sealing would occur from the attic side typically using spray foam or caulking.

Seal here along all top plates on both interior and exterior walls.

Another option would be to use spray applied foam on the interior to seal the exterior plywood or OSB. When SPF is used as an air barrier, the walls are typically netted and blown-in insulation is used to fill the cavity. Batt insulation is not as effective as blown-in due to batts not being in full and secure contact to all sides. SPF that is used as an air barrier does have specific fill requirements as outlined in section 6. Again as in the photo on the previous page, vertical studs only need to be sealed where there is an exterior plywood or OSB seam.



## Windows and doors



Gaps between framing and windows or doors shall be sealed with minimally expansive foam.



## Cantilevered Floors

Airtight blocking is installed between joists where the wall rim joist would have been located in the absence of a cantilever.

Exterior sheathing is installed to the bottom of the cantilever so that there is a continuous air barrier for the cantilever. The cantilevered joist must be insulated to the same R-value as would be required for the subfloor prior to closing.

Any Gaps, cracks or penetrations in the air barrier of the cantilever are sealed. Can lights in the cantilever are ICAT rated and properly sealed to the sheathing.

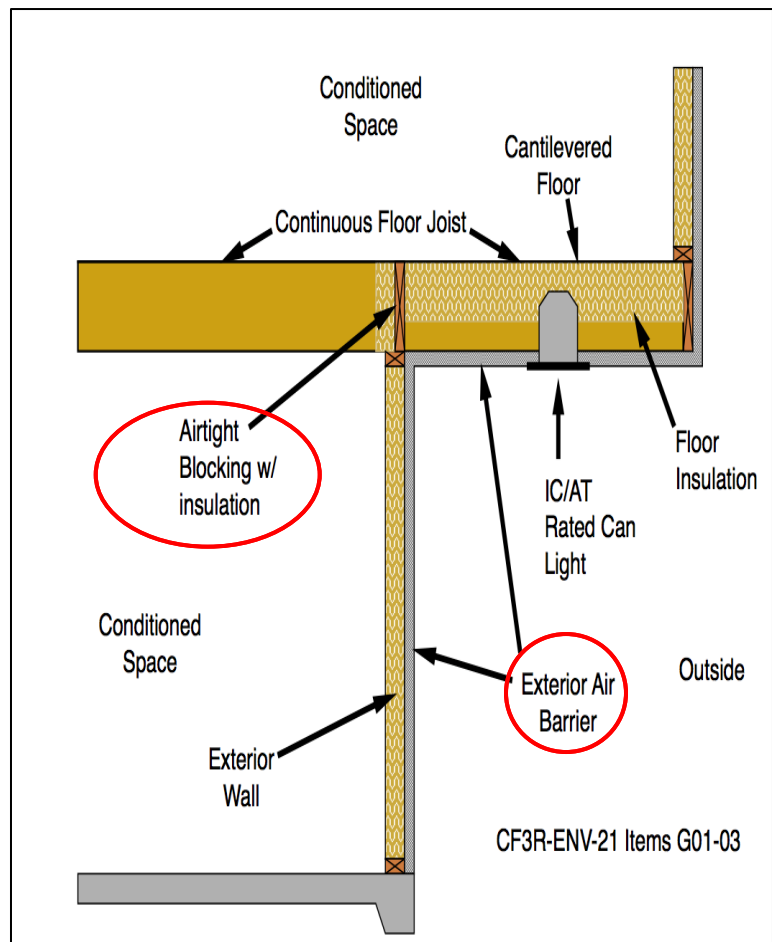



## 6. Insulation Types

### Thermal Specifications: **Batt and Blanket**

Reference: [RA3.5.3.1](#)



Batt and blanket insulation are made of mineral fiber and mineral wool, either:

- Processed fiberglass, rock or slag wool (mineral fiber);
- Natural wool products-animal wool or cotton-based products; or
- Cellulose materials.

This type of insulation is manufactured in different widths, lengths, and thicknesses and is available with or without paper facing. Faced batt and blanket insulation is also available with or without an attachment flange.

The installed insulation must meet the R-value claimed on the compliance documentation (CF1R) for each specific assembly.





## Thermal Specifications: **Loose fill**

Reference: [RA3.5.4.1](#)



Loose fill insulation includes loose fibers or fiber pellets that are blown into building cavities or attics using special equipment. Typical loose fill insulation products include mineral fiber (fiberglass or rock-wool) or cellulose. They are installed in walls, floors, attics and below roofs using a dry-pack process or a moist-spray technique. They may include a netting material for support.

The walls and ceiling are netted to help support the blown-in insulation until drywall is installed.

Its overall R-value is dependent on the installed density and installed thickness.





### **Installed Depth - Loose Fill (Fiberglass and Cellulose)**

Loose fill insulation shall be blown in to create a uniform appearance. Insulation levels shall be verified by checking that the depth of the insulation meets the manufacturer's specifications to achieve the R-value claimed on the CF1R.

**The HERS Rater shall measure the installed thickness in at least six random locations per opaque surface type: wall, roof, ceiling or floor.**

For cellulose insulation, this verification should consider the time that has elapsed since the insulation was installed. At the time of installation, the insulation should be greater than or equal to the manufacturer's minimum initial insulation thickness. If the

HERS Rater does not verify the insulation thickness at the time of installation, and if the insulation has been in place less than seven days, the insulation thickness should be greater than the manufacturer's minimum required thickness to achieve the given R-value at the time of installation, less 1/2 inch to account for settling. If the insulation has been in place for seven days or more, the insulation thickness should be greater than or equal to the manufacturer's minimum required settled thickness to achieve the given R-value.

### **Installed Weight per Square Foot - Loose Fill Fiberglass Only**

For loose fill fiberglass insulation installed in attics, the installed weight per square foot must be verified against the manufacturer's specification for the target R-value. Verification shall be determined using the methods of the *Insulation Contractor's Association of America (ICAA) Technical Bulletin #17*, except that only one sample should be taken in the area that appears to have the least amount of insulation. Verification of the installed weight per square foot is not applicable to loose fill cellulose. How to measure insulation is called the "cookie cutter test" and is covered at the end of this manual.

## Thermal Specifications: Rigid Foam Board

Reference: [RA3.5.5.1](#)



Rigid foam board insulation is made from fiberglass, expanded polystyrene (EPS), extruded polystyrene (XPS), polyisocyanurate or polyurethane. This type of insulation is used for exterior walls, cathedral ceilings, basement walls, perimeter insulation at concrete slab edges, to insulate special framing situations such as window and door headers, around metal seismic bracing and above roof decks. Rigid foam board insulation may also be integral to exterior siding materials. Seams in rigid foam board insulation must be sealed if it also serves as a component in the air-barrier. Installed on the exterior, rigid foam board creates a valuable thermal break to the structural framing.

The R-value is dependent on the type of material and its thickness. Specific product R-values are readily available from the manufacturer for the specific materials being installed. R-value of the product is typically marked on the product. The installed insulation must meet the R-value stated on the compliance documentation.





## Thermal Specifications: **Spray Polyurethane Foam (SPF)**

Reference: [RA3.5.6.1](#)



Spray polyurethane foam is a two-part liquid foamed plastic material formed by the reaction of an isocyanurate and a polyol. This application uses a blowing agent to develop a cellular structure when spray applied onto a substrate. SPF insulation can be formulated to have specific density, compressive strength, fire resistance and R-value.



There are two types of SPF insulation:

- **Closed Cell** - has a default R-value of R-5.8 per inch.
- **Open Cell** - has a default R-value of R-3.6 per inch.

Alternatively, the total R-value may be calculated based on the thickness of insulation multiplied by the "tested R-value per inch" as listed in the Table of R-values or R-value Chart from the manufacturer.

### Thermal Specifications: **Closed Cell SPF - ccSPF**

Reference: [RA3.5.6.1.1](#)

#### **Medium Density Closed-Cell SPF (ccSPF):**

A spray applied polyurethane foam insulation having a closed cellular structure resulting in an installed nominal density of greater than 1.5 to less than 2.5 pounds per cubic foot. Typically has a more rigid feel to the touch.

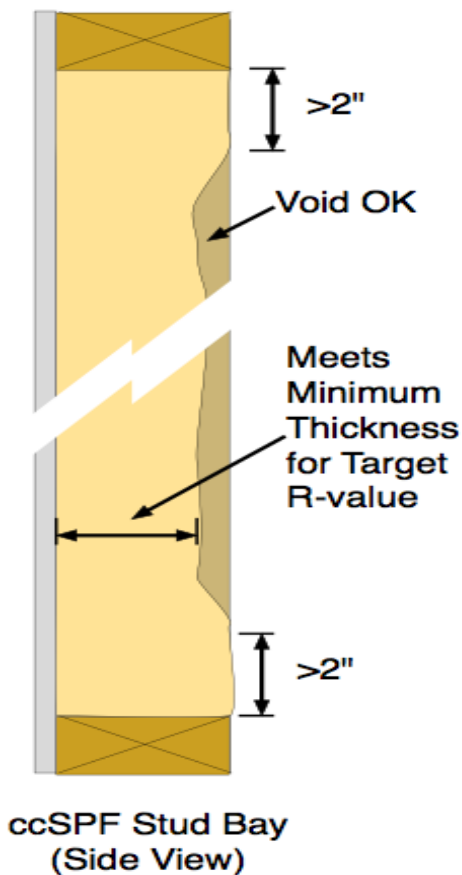



**R-value:** The total R-value shall be calculated based on the nominal required thickness of the insulation multiplied by a thermal resistivity of 5.8 per inch. The R-value of ccSPF insulation shall meet or exceed the installed thickness specified in Table 3.5-1 below.

The R-value of the installed insulation shall be based on the verified thickness at an R-value of 5.8 per inch unless an Evaluation Service Report (ESR) is provided with compliance documentation that verifies use of other values (see previous discussion).

Table RA3.5-1-CC: Required Thickness of ccSPF Insulation to Achieve Specified R-Values									
Equivalent R-Values for SPF Insulation	R-11	R-13	R-15	R-19	R-21	R-22	R-25	R-30	R-38
Required Thickness of ccSPF Insulation @ R-5.8/inch	2.00"	2.25"	2.75"	3.5"	3.75"	4.00"	4.50"	5.25"	6.75"

**Nominal Thickness:** ccSPF sprayed into framed cavities or on flat surfaces will expand with variable thicknesses, visibly appearing as undulations on the surface of the insulation. The average thickness of the foam insulation must meet or exceed the required R-value. Depressions in the foam insulation’s surface shall not be greater than 1/2 inch (less than) the required thickness at any given point of the surface area being insulated.

**Filling of Framed Assemblies:** ccSPF insulation is not required to fill the cavities of framed assemblies provided the installed thickness of insulation conforms to compliance documentation and that the bottom and top plates of vertical framing and both ends of horizontal framing, including band and rim joists, are sprayed to completely fill the cavity adjacent to and in contact with the framing to a distance of 2.0 inches away from the framing for ccSPF insulation, or filled to the thickness meeting ASTM testing as an air barrier.

**Air Barrier:** ccSPF installed as an air barrier shall be a minimum of 2.0 inches in thickness; alternatively, ccSPF insulation shall be installed at a thickness that meets an air permeance no greater than 0.02 L/s-m<sup>2</sup> at 75 Pa pressure differentials when tested in accordance to ASTM E2178 or ASTM E283.

## Thermal Specifications: **Open Cell SPF - ocSPF**

Reference: [RA3.5.6.1.2](#)

### **Low Density Open-Cell SPF (ocSPF):**

A spray applied polyurethane foam insulation having an open cellular structure resulting in an installed nominal density of 0.4 to 1.5 pounds per cubic foot. Tends to have a softer, spongy feel.

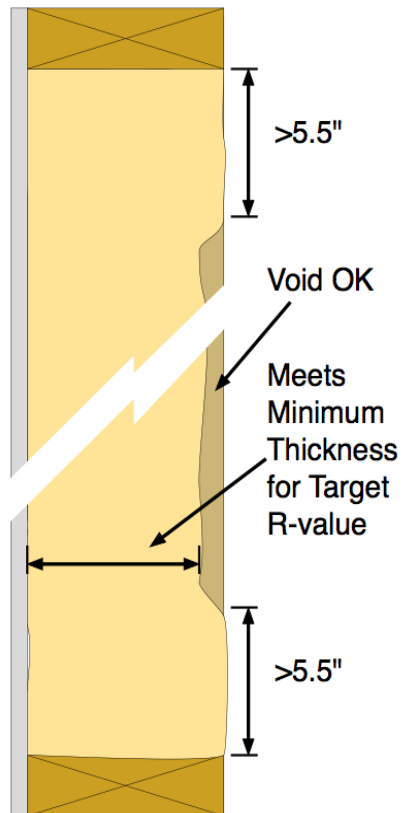

ocSPF Stud Bay  
> 2 x 4  
(Side View)

**R-value:** The total R-value shall be calculated based on the nominal required thickness of the insulation multiplied by a thermal resistivity of 3.6 per inch. The R-value of ocSPF insulation shall meet or exceed the installed thickness specified in Table 3.5-1 below

The R-value of the installed insulation shall be based on the verified thickness at an R-value of 3.6 per inch unless an ESR is provided with compliance documentation that verifies use of other values

Table RA3.5-1-OC: Required Thickness of ocSPF Insulation to Achieve Specified R-Values									
Equivalent R-Values for SPF Insulation	R-11	R-13	R-15	R-19	R-21	R-22	R-25	R-30	R-38
Required Thickness of ocSPF Insulation @ R-3.6/inch	3.0"	3.5"	4.2"	5.3"	5.8"	6.1"	6.9"	8.3"	10.6"

**Nominal Thickness:** ocSPF sprayed into framed cavities or on flat surfaces will expand with variable thicknesses, visibly appearing as undulations on the surface of the insulation. The average thickness of the foam insulation must meet or exceed the required R-value. Depressions in the foam insulation surface shall not be greater than **1/2 inch** of the required thickness provided these depressions do not exceed 10% of the surface area being insulated.

**Filling of Framed Assemblies:** ocSPF insulation shall completely fill cavities of 2x4 inch framing or less. Cavities greater than 2x4 inch framing dimensions may be filled to the thickness that meets the required R-value used for compliance provided that the bottom and top plates of vertical framing and both ends of horizontal framing, including band and rim joists, are sprayed to completely fill the cavity adjacent to and in contact with the framing to a distance of 5.5 inches away from the framing for ocSPF insulation, or filled to the thickness meeting ASTM testing as an air barrier.

**Air Barrier:** ocSPF installed as an air barrier shall be a minimum of 5.5 inches in thickness; alternatively, ocSPF insulation shall be installed at a thickness that meets an air permeance no greater than 0.02 L/s-m<sup>2</sup> at 75 Pa pressure differentials when tested in accordance to ASTM E2178 or ASTM E283.

**ocSPF is NOT an air barrier in 2x4 framing.**

## 7. Insulation Inspection

The following discussion has been taken directly from the protocols of RA3.5. Inspection details have been generalized for all insulation types with supplemental notes for specific insulation types where applicable.

Insulation is installed at different stages during the construction process. It is incumbent upon the HERS Rater and builder to coordinate schedules to ensure access for verification.

Insulation shall be uniformly installed to completely fill the building cavity without any voids, gaps or excessive compression. The installed insulation shall be in full and secure contact with its associated air barriers and form a continuous thermal barrier around all of the conditioned space.

**Exception:** ocSPF insulation shall completely fill cavities of 2x4 inch framing or less. Cavities greater than 2x4 inch framing dimensions may be filled to the thickness that meets the required R-value used for compliance provided that the bottom and top plates of vertical framing and both ends of horizontal framing, including band and rim joists, are sprayed to completely fill the cavity adjacent to and in contact with the framing to a distance of 5.5 inches away from the framing for ocSPF insulation, or filled to the thickness meeting ASTM testing as an air barrier.

**Exception:** ccSPF insulation is not required to fill the cavities of framed assemblies provided the installed thickness of insulation conforms to compliance documentation and that the bottom and top plates of vertical framing and both ends of horizontal framing, including band and rim joists, are sprayed to completely fill the cavity adjacent to and in contact with the framing to a distance of 2.0 inches away from the framing for ocSPF insulation, or filled to the thickness meeting ASTM testing as an air barrier.

### **Uniform:**

Having always the same form, manner, or degree. Not varying or variable. Consistent. Presenting an unvaried appearance of surface, pattern, density or other material property.

In vertical cavities such as stud bays and attic knee walls, the installed insulation shall fill the cavity front to back, side to side and top to bottom. Stud bays must be substantially airtight with an air barrier on six sides and the installed insulation must be in full and secure contact on all six sides.

Insulation in ceilings and floors shall fully fill the joist bays side to side, end to end, and be in full and secure contact with the associated air barrier. Mechanically supporting insulation between floor joists to maintain its contact with the subfloor air barrier is always problematic and should receive special attention during verification. Where the insulation installed in a joist bay exceeds the height of the joist, the void created by the absence of the joist shall be uniformly filled with insulation. Gaps, voids or excessive compression are not allowed.

**Note:** *It is virtually impossible to pass QII using batt insulation in an attic due to voids created by the ceiling joists as insulation exceeds the height of the joist and other obstructions created by truss chords, bracing, electrical wiring, plumbing, mechanical systems and flue vents.*

Batt and blanket insulation that is thicker than the framing depth shall be installed so that the insulation expands to touch adjacent insulation over each framing member.



## Thermal Specifications

Reference: [RA3.5.X.1](#)

Specific product R-values are readily available from the manufacturer for the materials being installed. The R-value of the product is also usually marked on the product or product packaging. Installers are required to make product specifications available for all insulation types installed. The HERS Rater should verify that the installed insulation achieves the R-value claimed on the CF1R for each building assembly.

**Note:** *In some special situations the compliance documentation may specify a reduced R-value for part of an assembly. For instance, an HVAC platform in an attic may not have enough space below it to allow insulation to the full depth required to achieve the desired R-value; a wall assembly may contain a pre-fab structural panel that cannot be insulated to the same levels as the adjacent wall assemblies. In these circumstances the CF1R should account for the reduced insulation levels by indicating an associated surface area with the reduced R-value of that assembly.*

### R-Value Measurement: **Batt Insulation**

Reference: [RA3.5.3.1.2](#)

The HERS Rater shall verify the installed thickness of insulation in all assemblies and locations on walls, roof/ceilings, and floors, and to ensure that insulation levels and installation integrity meet the R-value specified on the Certificate of Compliance, and all other required compliance documentation.

## R-Value Measurement: **Blown-in Insulation**

Reference: [RA3.5.4.1.2](#)

The HERS Rater shall measure the installed thickness (inches) and density (lbs. per square foot) in at least 6 random locations on walls, roof/ceilings and floors (i.e., 6 measurements per opaque surface type: wall, roof/ceiling or floor) to ensure minimum thickness levels and the installed density meets the R-value specified on the Certificate of Compliance, and all other required compliance documentation. For walls, measurement areas shall include low and high areas of the insulated assembly and the HERS Rater shall verify density measurements are consistent with the manufacturer's coverage chart.

(See "Cookie Cutter Test" section on page 92).

Owens Corning PROPINK I77 PINK (Fiberglass)						
Product Description		Summary Coverage Chart				
	R-value	Bag Requirements	Max Coverage	Min Weight	Min Installed Thickness	Min Settled Thickness
	To obtain thermal resistance (R) of:	# of bags per 1,000 sq ft of net area:	Contents of bag shall not cover more than (sq ft):	Wt per sq ft of installed insulation shall not be less than: (lbs/sq ft)	Should not be less than (in):	Should not be less than (in):
	R-13	5.5	182.9	0.18	4.75	4.75
	R-19	8.1	124.2	0.266	6.75	6.75
	R-22	9.4	106.9	0.311	7.75	7.75
	R-25	11.2	89.6	0.368	9	9
	R-30	13	77	0.428	10.25	10.25
	R-38	16.8	59.5	0.555	12.75	12.75
	R-44	20.1	49.8	0.662	14.75	14.75
	R-49	22.6	44.2	0.747	16.25	16.25
R-60	28.5	35.1	0.94	19.5	19.5	

## R-Value Measurement: Rigid Insulation

Reference: [RA3.5.5.1.1](#)

The HERS Raters shall verify the installed thickness of insulation in all assemblies and locations on walls, roof/ceilings, and floors, and to ensure that insulation levels and installation integrity meet the R-value specified on the Certificate of Compliance, and all other required compliance documentation. Different products will have different R-values per inch.

**Note:** Rigid insulation is sometimes referred to as "sheathing" or "continuous" insulation on the CF1R. Sometimes the surface will be named something like "R-15+4 wall", meaning that there is R-15 in the cavity (between studs) and R-4 continuous insulation, usually on the exterior of the wall. It is important to realize that the name of a surface on the CF1R is just a text field and has no impact on the simulation results. You have to look at the detailed description and U-factor to determine what is actually required. In other words, a surface mis-named "R-13 wall" may have actually been modeled as an R-15+4 wall. This can easily cause a lot of confusion.



## R-Value Measurement: **SPF Insulation**

Reference: [RA3.5.6.1.4](#)

The HERS Rater shall measure the installed thickness of insulation in at least 6 random locations on walls, roof/ceilings and floors (i.e., 6 measurements per opaque surface type: wall, roof/ceiling or floor) to ensure minimum thickness levels necessary to meet the R-value specified on the Certificate of Compliance, and all other required compliance documentation. Measurement areas shall include low and high areas of the SPF insulated surface.

Probes are typically used for inspection and measurement of installed thickness of SPF insulation. The insulation thickness shall be verified by using a probe, gauge or device capable of measuring the installed thickness of insulation. A pointed measurement probe or other gauge or device, capable of penetrating the full thickness of the insulation, shall be used having measurements marked by at least one-eighth inch increments. Insulation thickness measurement probes and gauges or devices shall be accurate to within  $\pm 1/8$  inch and shall be designed and used in a manner to cause minimal damage to the insulation. A metal skewer and ruler are commonly used.



## 8. General Requirements for Walls, Roof/Ceilings and Floors: All Materials

Reference: [RA3.5.X.1.1](#)

- Materials shall comply with, and be installed in conformance with, all applicable building codes for building.
- Materials shall meet California Quality Standards for Insulating Material, Title 24, Part 12, Chapter 4, Article 3, listed in the California Department of Consumer Affairs Consumer Guide and Directory of Certified Insulating Materials.
- Materials shall comply with flame spread rating and smoke density requirements of Chapter 26 and Section 720 of the Title 24, Part 2: all installations with exposed facings must use fire retardant facings which have been tested and certified not to exceed a flame spread of 25 and a smoke development rating of 450. Insulation facings that do not touch a ceiling, wall, or floor surface, and faced batts on the undersides of roofs with an air space between the ceiling and facing are considered exposed applications.
- Insulation shall be installed in full and secure contact with its associated air barriers.
- Insulation shall be correctly sized to fit snugly at the sides and ends without gaps, voids or excessive compression.
- Materials shall be installed according to manufacturer specifications and instructions.
- Hard covers or draft stops shall be placed over all drop ceiling areas and interior wall cavities to keep insulation in place and stop air movement. If hard covers or draft stops are missing or incomplete, they shall be completed before insulation is installed.
- Eave vent baffles shall be installed to prevent air movement under or into the insulation (wind washing). The net free-ventilation area of the eave vent shall be maintained by the baffles.
- Required eave ventilation shall not be obstructed - the net free-ventilation area of the eave vent shall be maintained.

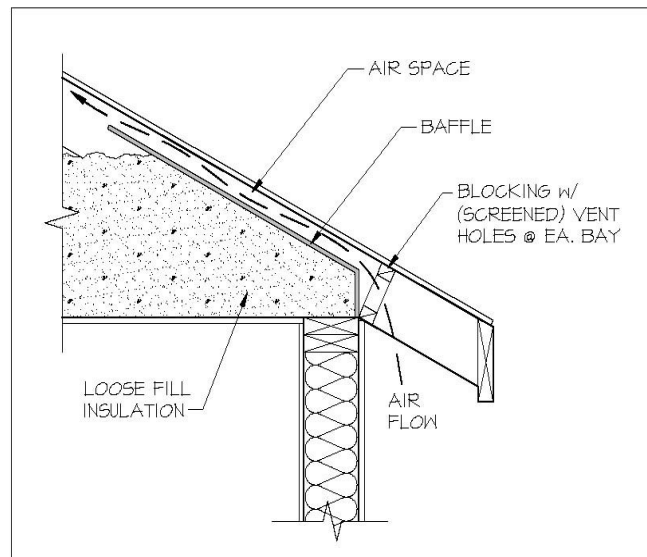



Insulation (**except SPF**) shall completely cover all recessed fixtures. All recessed fixtures shall be IC/AT rated. Additionally, recessed fixture should be sealed with a gasket or caulk between the light's housing and the ceiling.



## Walls, Roof/Ceilings and Floors: **Batt and Blanket**

Reference: [RA3.5.3.1.1](#)

- Batt and blanket insulation shall be correctly sized to fit snugly at the sides and ends. (aka, Six-sided Contact)
- Batt and blanket insulation shall be installed so that they will be in contact with the air barrier.
- Where necessary, batt and blanket insulation shall be cut to fit properly - there shall be no gaps, nor shall the insulation be doubled-over or compressed.
- When batt and blanket insulation are cut to fit a non-standard cavity, they shall be snugly fitted to fill the cavity without excessive compression.
- 
- Batt and blanket insulation shall be cut to butt-fit around wiring and plumbing, or be split (delaminated) so that one layer can fit behind the wiring or plumbing, and one layer fit in front.
- For batts and blanket insulation that is taller than the trusses, full-width batts shall be used so that they expand to touch each other over the trusses.

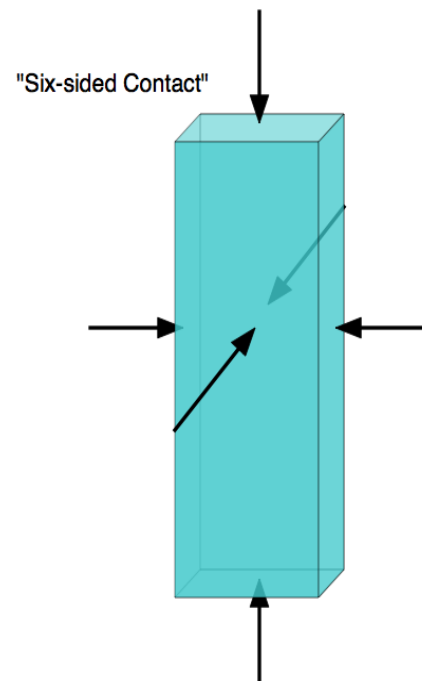

## Walls, Roof/Ceilings and Floors: **Loose Fill**

Reference: [RA3.5.4.1.1](#)

- Loose-fill insulation must completely fill the framed cavity.
- Loose-fill insulation shall be installed so that it will be in contact with the air barrier.

## Walls, Roof/Ceilings and Floors: **Rigid Board**

Reference: [RA3.5.5.1](#)

- Rigid board insulation shall be attached according to the manufacturer's specifications.
- Rigid board insulation may be used as the air barrier provided it has been tested to conform to the air barrier performance conditions of the Standards.

## Walls, Roof/Ceilings and Floors: **SPF**

Reference: [RA3.5.6.1.3](#)

- The installer shall determine and the HERS Rater shall verify that the manufacturer's nominal insulation thickness has been installed and certified and that all requirements of the Certificate of Verification have been met.
- The installer shall determine and the HERS Rater shall verify that insulation is in substantial contact with the assembly air barrier. When SPF insulation is being used to provide air barrier control, the SPF insulation must cover and be in contact with the entire surface of the framing, filling the cavity to a distance away from the framing specified in "Filling of Framed Assemblies" previously presented.
- SPF insulation shall be spray-applied to fully adhere to assembly framing, floor and ceiling, the joists, and other framing surfaces within the construction cavity. When multiple layers of SPF material are applied, each foam lift (i.e. spray application) shall have adhesion at substrate and foam interfaces.

SPF insulation shall not exhibit areas that:

1. Have voids or gaps in the uniformity of the insulation.
2. Are extremely soft or spongy.
3. Show the presence of liquid.
4. Have blistering between lifts.
5. Show differences in coloration of adjacent foam layers.
6. Indicate the presence of other materials between lifts.

Recessed light fixtures in ceilings insulated with SPF insulation shall be protected from contact with SPF by a combination of one or more of the following methods:

1. Be covered with a minimum of 1.5 inches of mineral fiber insulation, or
2. Be enclosed in a box fabricated from 1/4-inch plywood, 18-gauge metal, 3/8-inch hardboard or sheetrock.

**Caution: SPF shall not be applied directly to recessed lighting fixtures.**

## 9. Specific Requirements for Wall Insulation

Reference: [RA3.5.X.2](#)

- Wall stud cavities shall be caulked or foamed to provide a substantially air-tight envelope to the outdoors, attic, garage and crawl space.
- All plumbing and wiring penetrations through the top and bottom plates and electrical boxes that penetrate the exterior sheathing shall be sealed.
- All gaps in the air barrier shall be caulked, taped, or sealed with minimally expansive foam.
- Bottom plates of framed and non-framed assemblies shall be sealed to the ground subfloor or slab, and above ground subfloor.
- Insulation shall uniformly fill the cavity side-to-side, top-to-bottom, and front-to-back.

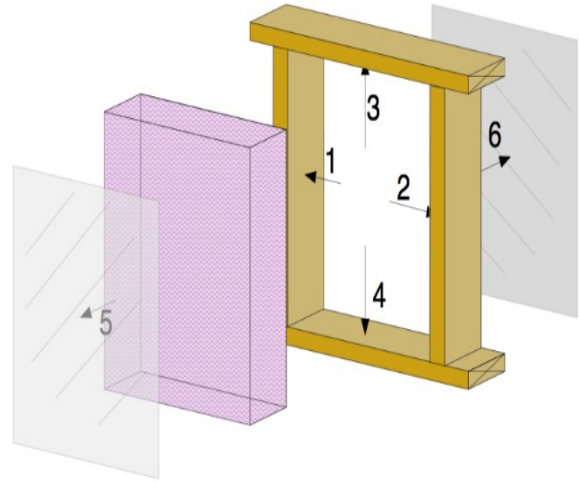

## Wall Insulation: Batt and Blanket

Reference: [RA3.5.3.2](#)

- Batt insulation shall fill the cavity by friction fitting, inset or face stapling of flanges of faced batts, or by other support methods as necessary.
- Batt and blanket insulation shall be installed to fill the cavity and be in contact with the sheathing on the back and the wallboard on the front - no gaps or voids.
- Non-standard-width cavities shall be filled with insulation fitted into the space without excessive compression.
- Batt insulation shall be cut to fit snugly around wiring and plumbing, or be split (delaminated) so that one layer can fit behind the wiring or plumbing, and one layer fit in front.

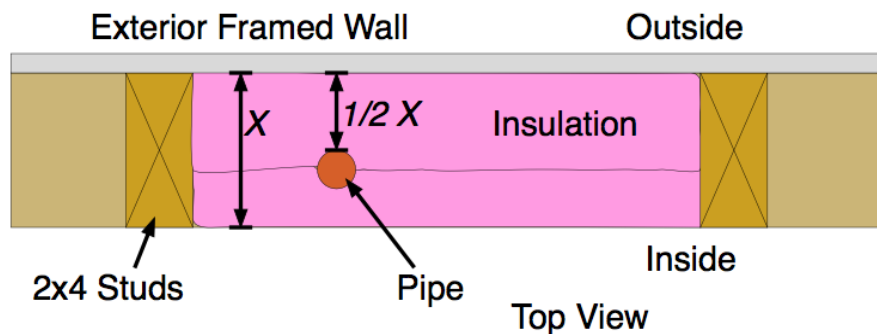
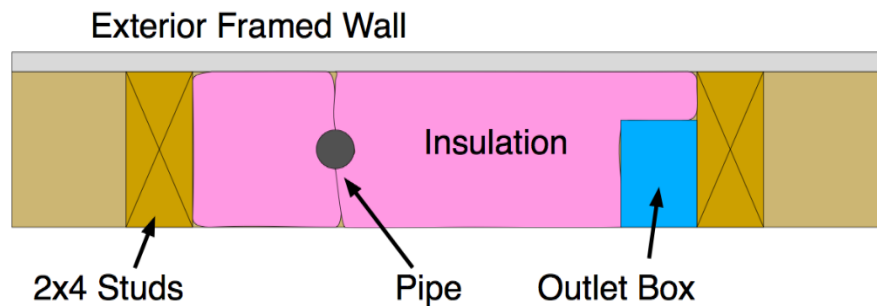



## Wall Insulation: **Loose Fill**

Reference: [RA3.5.4.2](#)

- Loose fill insulation shall be installed to fill the cavity and be in contact with the sheathing on the back and the wallboard on the front - no gaps or voids.
- Loose fill wall insulation shall be installed to fit around wiring, plumbing, and other obstructions.



## Wall Insulation: **Rigid**

Reference: [RA3.5.5.2](#)

Installation shall uniformly fit across the plane of the wall and **taping** and/or **caulking** of all joints and seams of the insulation shall be maintained to be considered as the air barrier.



### Wall Insulation: **SPF**

Reference: [RA3.5.6.2](#)

SPF insulation shall be applied to provide an air-tight envelope to the outdoors and between adjoining cavity surfaces of conditioned and unconditioned space, such as the: attic, garage, and crawl space. See **Thermal Specifications** section for more detail.

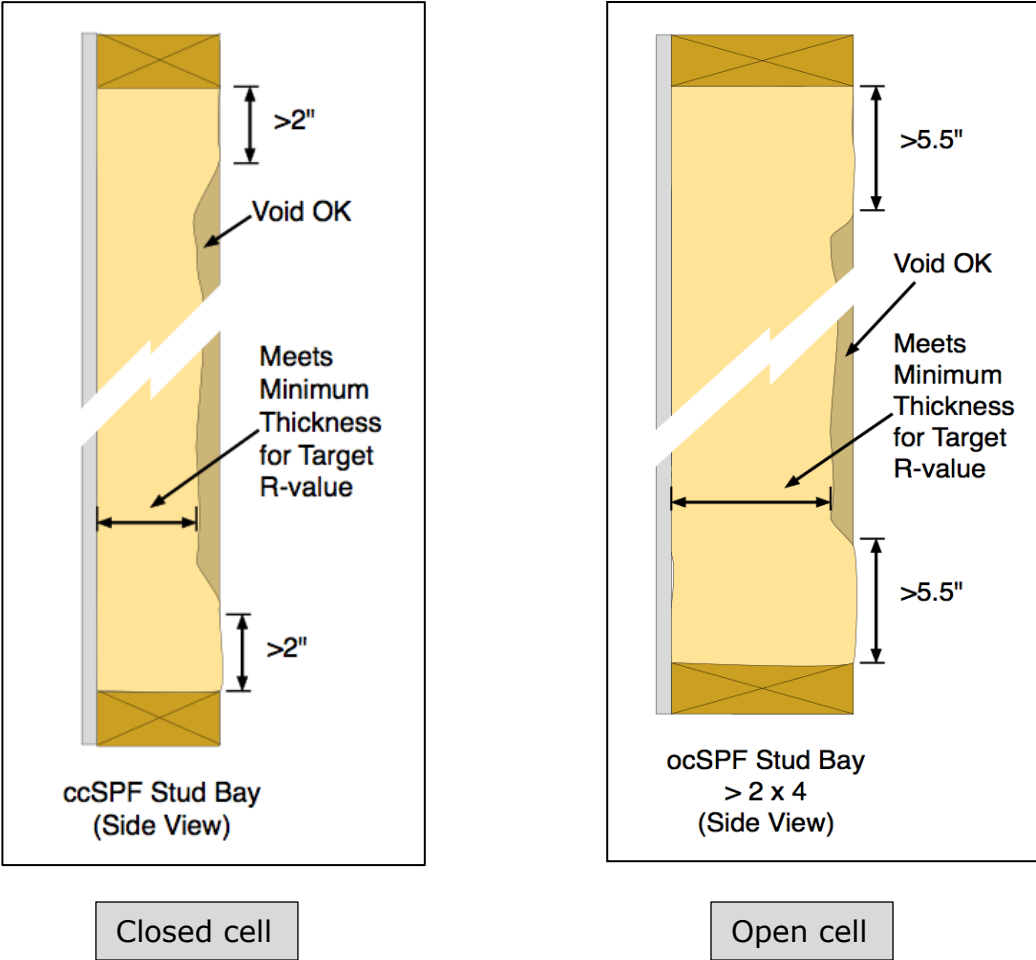

## Narrow-Framed Cavities

Reference: [RA3.5.X.2.1](#)



Non-standard width cavities shall be filled with insulation to snugly fit into the space, or with minimally expansive foam sealing material.

Narrow spaces less than 1 inch in width at windows and door jambs, shall be filled with minimally expansive foam sealing.

Narrow spaces less than 2 inches in width, such as between studs at building corners, and at the intersection of interior partition walls to exterior walls, shall be filled with insulation snugly fitted in the space, or with minimally expansive foam sealing.



## 10. Special Situations

### Special Situations - Installation Prior to Exterior Sheathing or Lath

Reference: [RA3.5.X.2.2](#)

Hard to access wall stud cavities, such as corner channels, wall intersections and behind tub/shower enclosures should be insulated to the proper R-value. In most cases, this can only be completed prior to the installation of the tub/shower enclosure, the exterior sheathing or the exterior stucco lath.

**Note:** Visual inspection of hard to access locations typically occurs early on in the framing stage of construction and for some locations may coincide with the associated air barrier inspection.

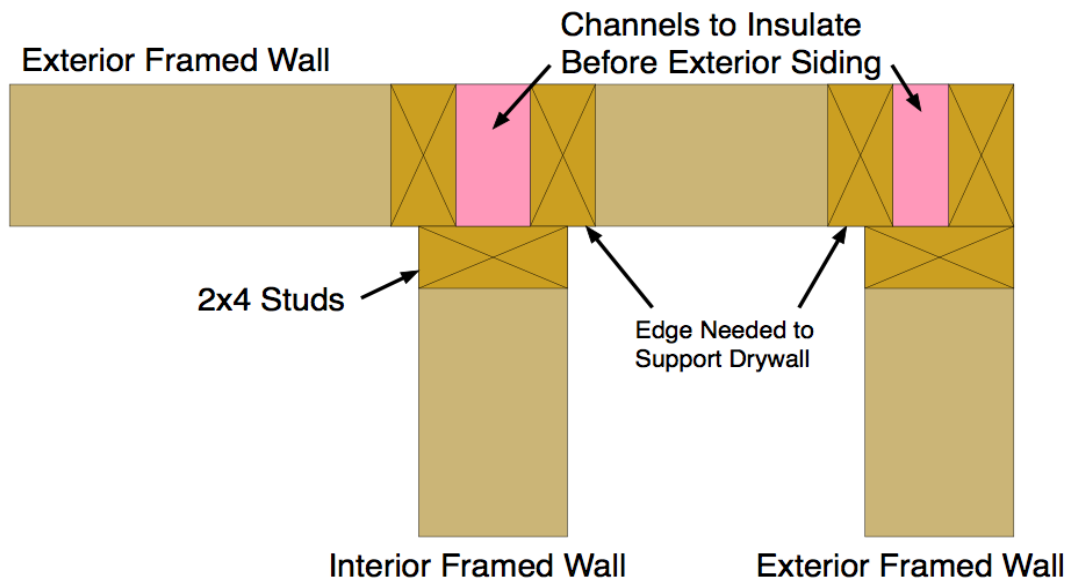



These two photos show bath tubs against exterior walls. When this happens an air barrier must be installed on the inside surface of the wall. The photo on the bottom shows the air barrier installed. You can also see a metal access door; this door needs to be insulated much the same way an attic access would be insulated. Rigid board insulation would work well here.

No air barrier behind tub.

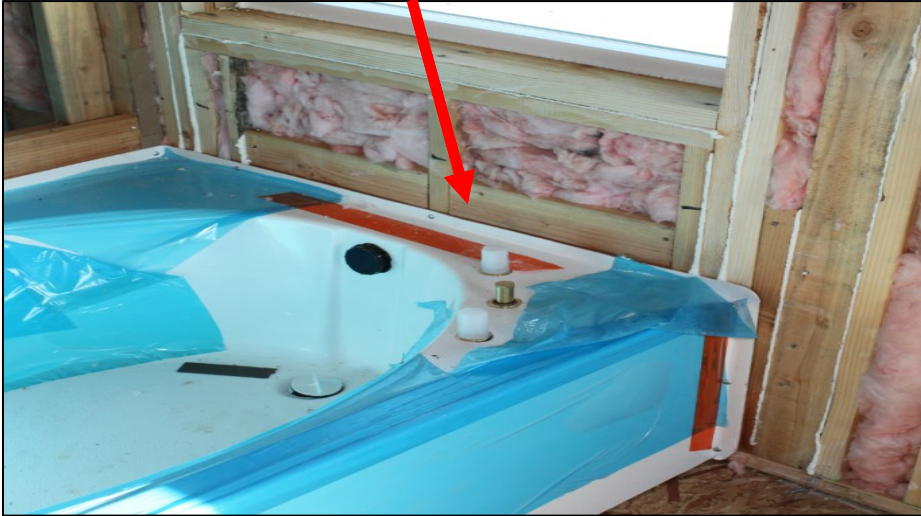

Air barrier present behind tub.



Metal access door needs to be insulated.



## Special Situations – Obstructions

Reference: [RA3.5.X.2.3](#)

Insulation shall be placed between the sheathing and the rear of electrical boxes and phone boxes.



This photo shows no insulation between the exterior of the wall and the cold-water line. This would fail a QII inspection.

In cold climates, such as climate zones 2, 11-14 and 16, where water pipes may freeze, pipes should have at least one-half of the insulation between the water pipes and the outside surface of the exterior walls. If the pipe is closer to the exterior finish assembly layers, as much insulation as possible should be placed between the pipe and the outside (without excessive compression). The remaining insulation should be placed between the pipe and the interior assembly material.

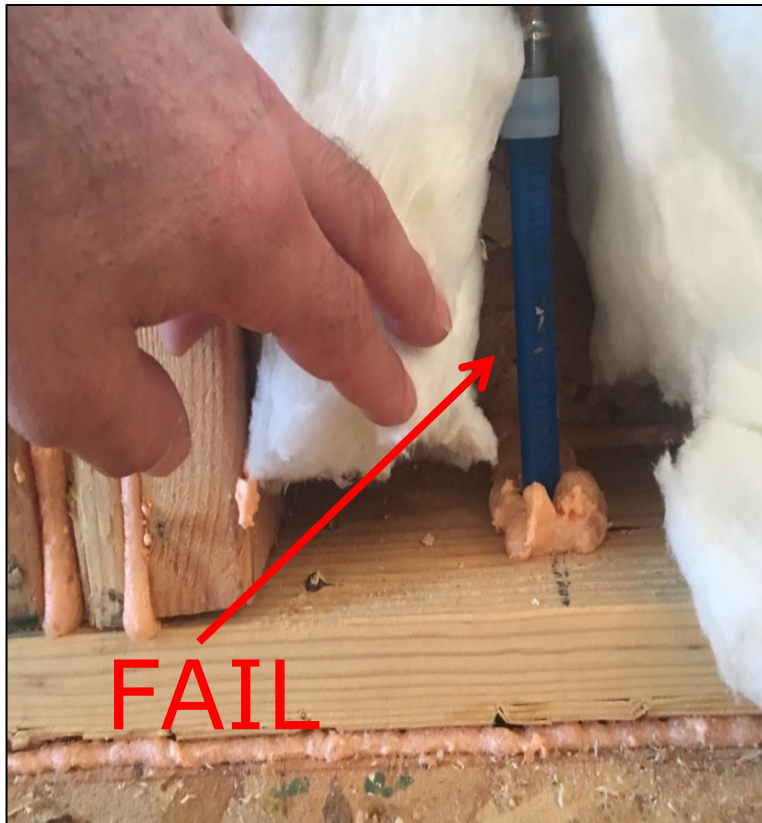

## Special Situations - Rim Joists

Reference: [RA3.5.X.2.4](#)

All rim-joists shall be insulated to the same R-value as the adjacent wall assembly.

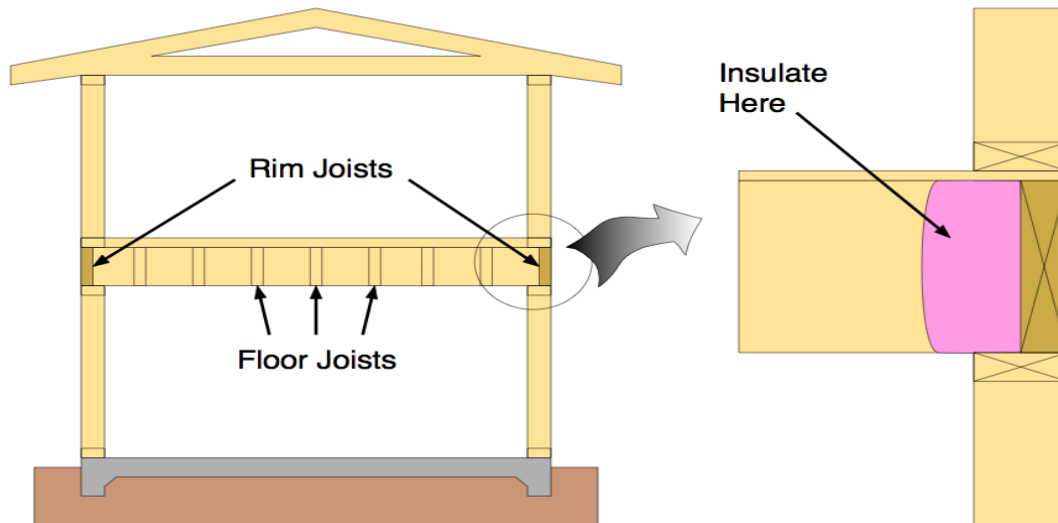

The insulation shall be installed without gaps, voids, or compression.



*This photo shows rim joists that have been insulated. Unfortunately, the work is too sloppy to meet QII. There is too much compression and there are too many voids.*

## Special Situations – Knee walls and Skylight Shafts

Reference: [RA3.5.X.2.5](#)

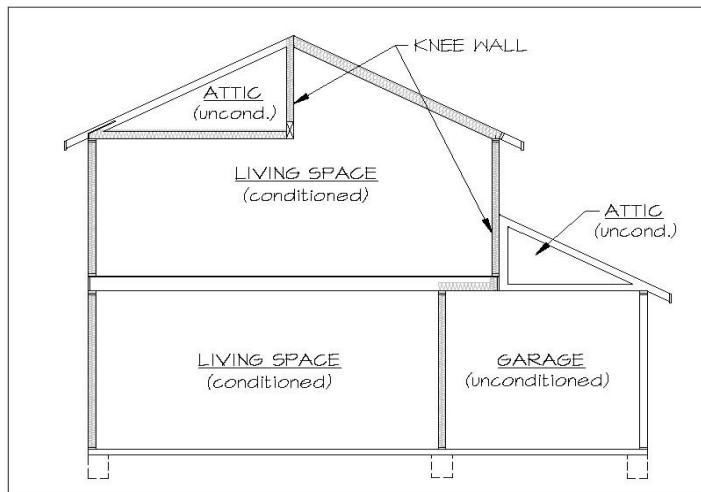

A knee wall is any vertical wall that separates conditioned space from an unconditioned attic

- Framing for knee walls and skylight shafts that separate conditioned from unconditioned space shall be insulated to meet or exceed the wall R-value specified on the Certificate of Compliance, and all other required compliance documentation. They can be specifically modeled in a performance run, but must meet or exceed the performance level of how they were modeled. If they are not specifically called out, they must meet the same U-factor as the rest of the walls with similar framing.
- Insulation shall uniformly fill the cavity side-to-side, top-to-bottom, and front-to-back insuring full and secure contact on all six sides without gaps, voids or excessive compression.
- Steel-framed knee walls, skylight shafts, and gable ends shall meet or exceed the mandatory minimum insulation requirements and external surfaces of steel studs shall be covered with continuous insulation unless otherwise specified on the CF1R.

Truss framing blocking is required at the top and bottom of each wall/roof section, in this case the knee wall. Also notice the dam at the top of the wall section. This will keep the insulation from falling over edge while maintaining full depth on the ceiling.

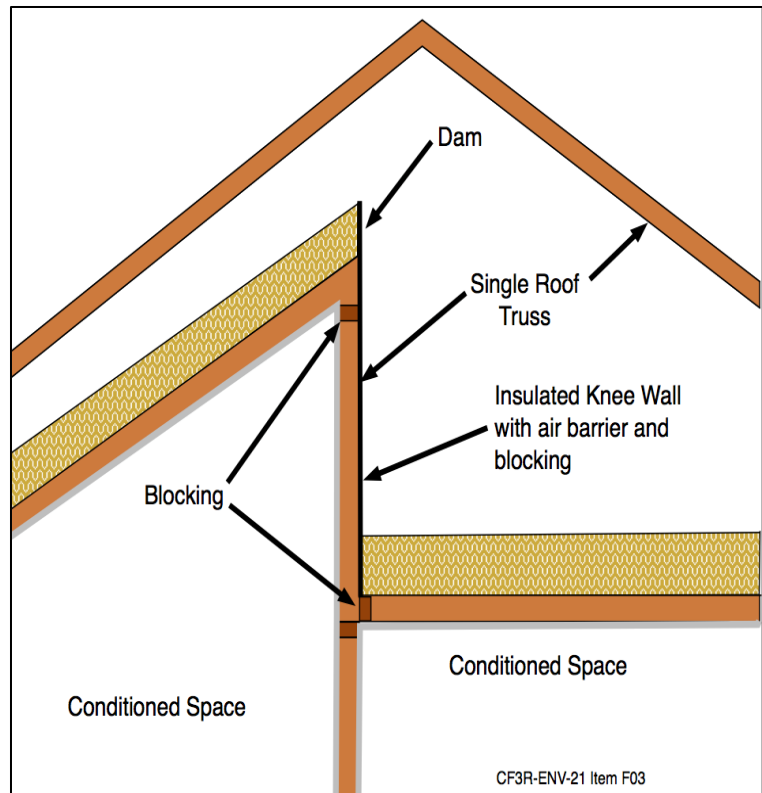

Where a knee wall sits on a subfloor, the spaces between the floor joists must be blocked and sealed to prevent air from moving between the attic and floor joist bays.

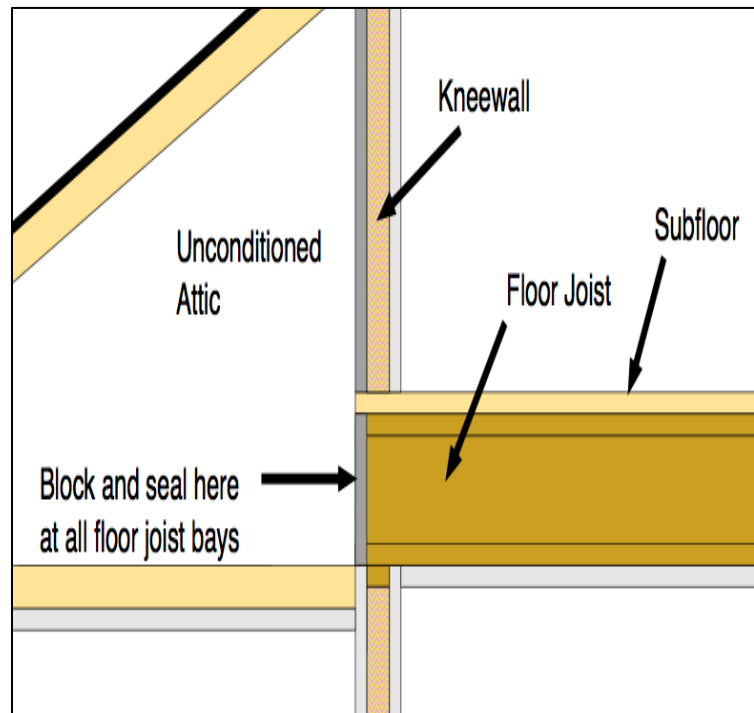

## Covered Porches/Knee Wall

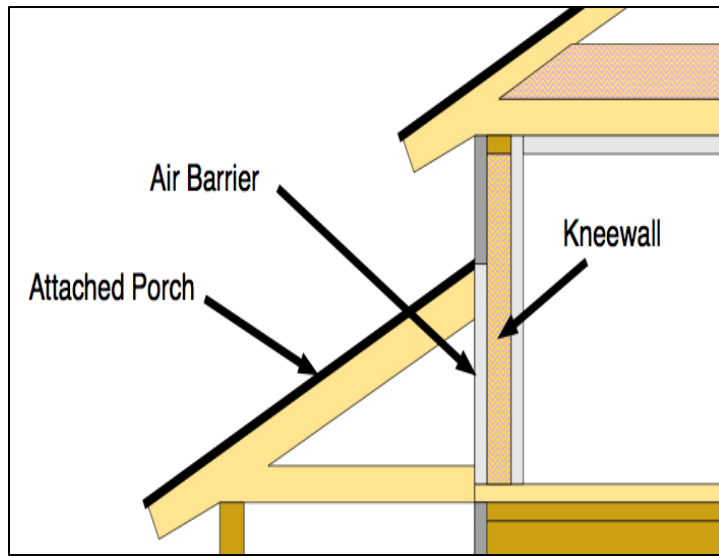

An exterior wall air barrier is required at the intersection of the porch and exterior wall when there is conditioned space on the other side. The exterior wall includes an air barrier where the attic attaches to the conditioned space.

- The backside of air permeable insulation exposed to the unconditioned attic space shall be completely covered with continuous air barrier.
- The house side of the insulation shall be in contact with the drywall or other wall finish.
- The insulation shall be supported so that it will not fall down by using support such as netting.

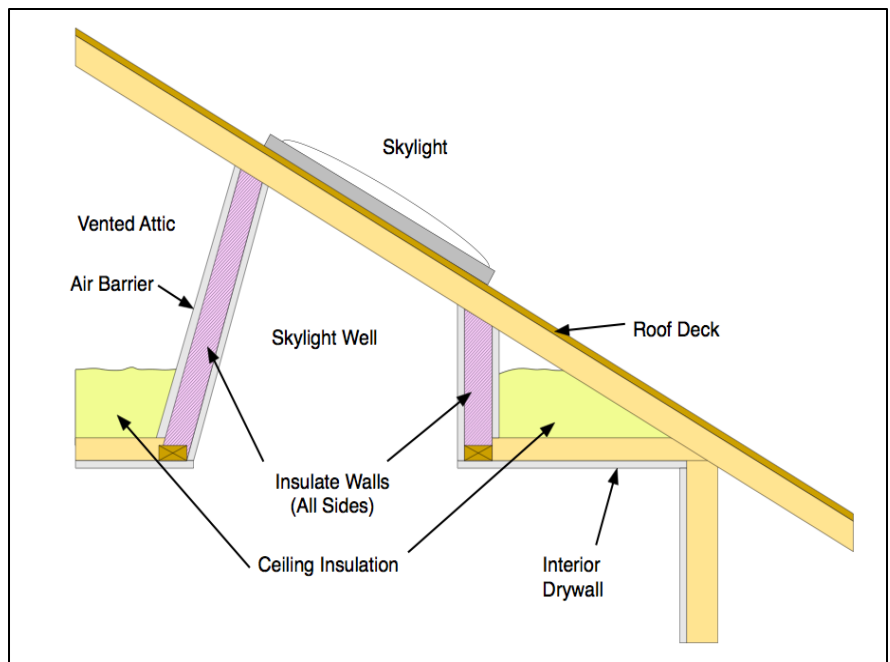

- Insulation for all knee wall and skylight shafts shall be completely enclosed by vertical and horizontal framing, including horizontal plates at top and bottom of the insulation.



In unvented attics, where insulation is applied directly to the underside of the roof deck. Knee walls, skylight shafts, and gable ends shall be insulated to meet or exceed the wall R-value specified on the Certificate of Compliance, and all other required compliance documentation. (Only where they separate conditioned and unconditioned space).

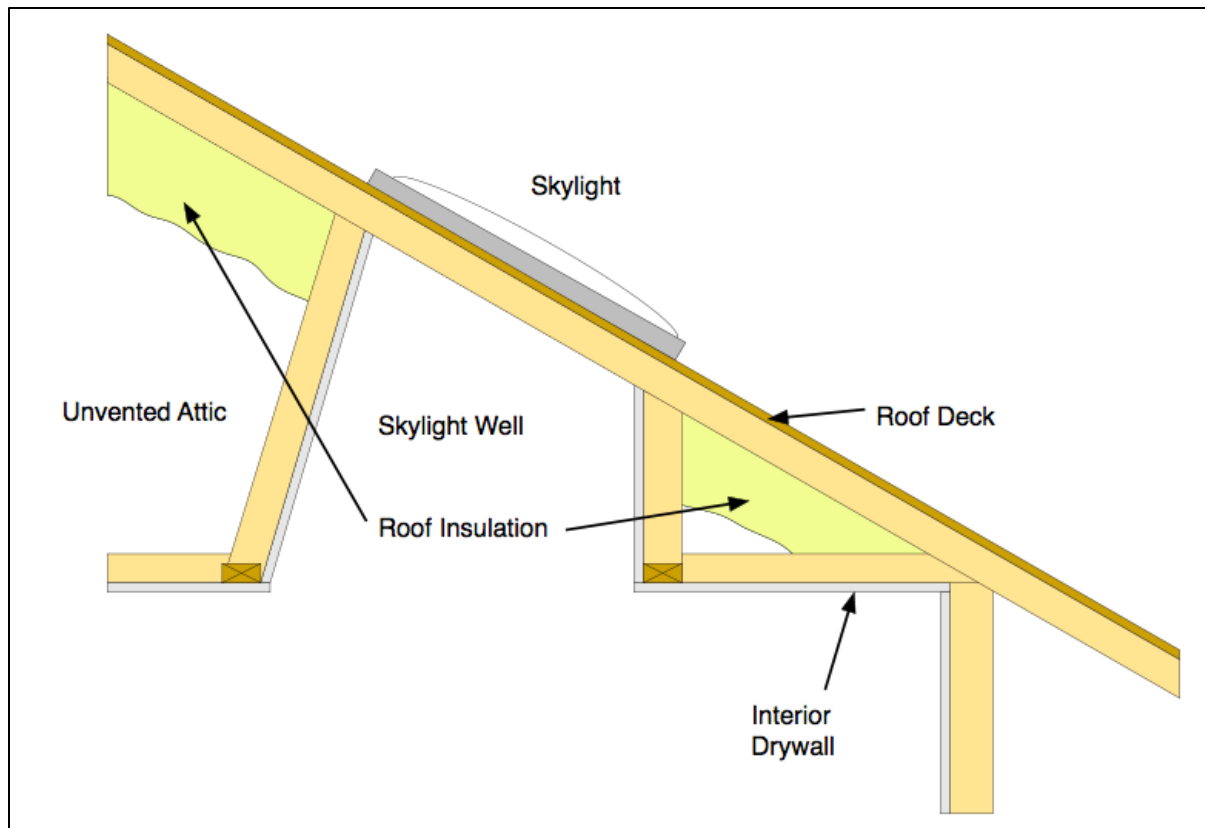

## Special Situations - HVAC/Plumbing Closet

Reference: [RA3.5.X.2.6](#)

- Walls of interior closets for HVAC or water heating equipment that require combustion ventilation air shall be insulated to the same R-value as the exterior walls as specified in the compliance documentation. The fact that these closets exchange air freely with unconditioned space (attic or crawlspace) makes them also unconditioned space. They, therefore, must be insulated wherever they are adjacent to conditioned space.
- Sealed combustion furnaces and water heaters with combustion air piped in via PVC pipe need not be installed in a closet that is vented. Similarly for heat pump fan coil units, electric water heaters, hydronic fan coils, and other appliances that do not burn gas. Unvented closets need not be insulated.

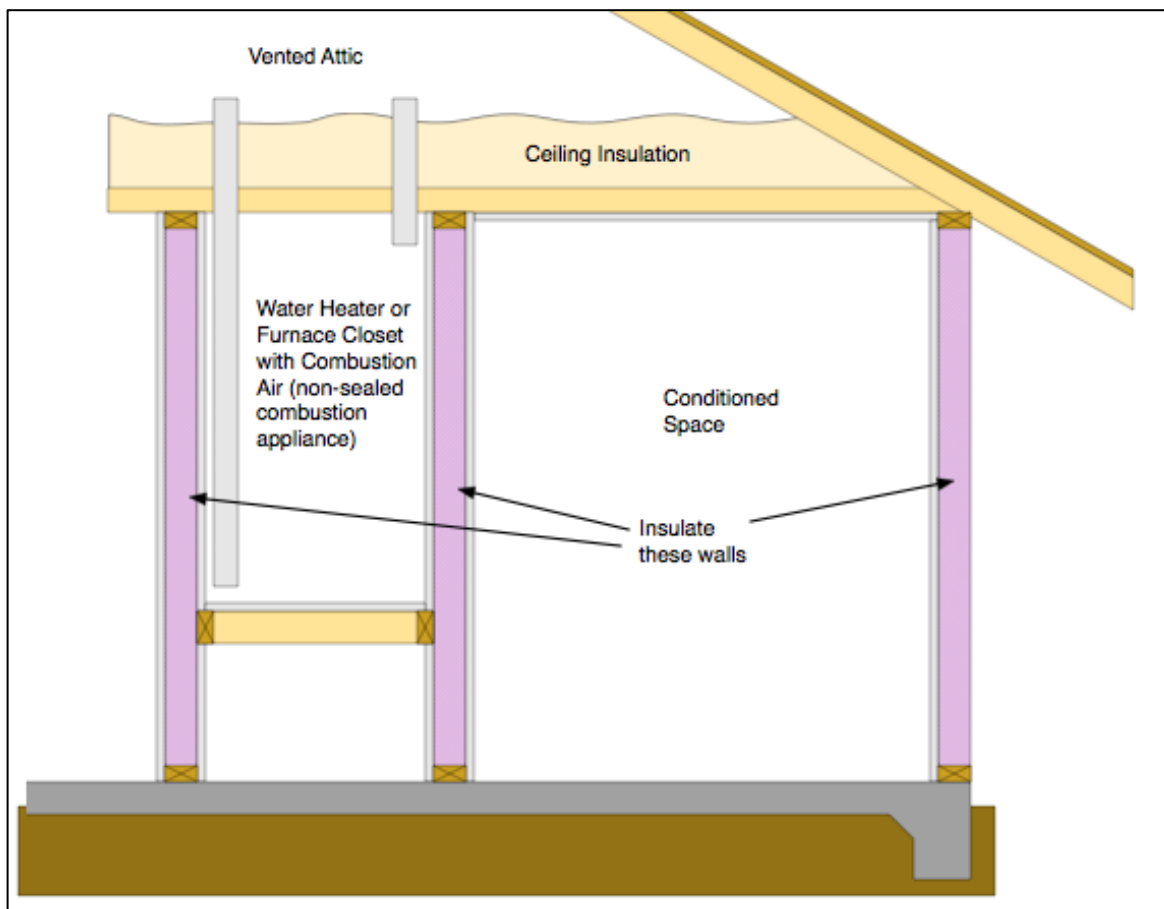

## Special Situations - Double Walls and Framed Bump Outs

Reference: [RA3.5.X.2.7](#)

- Insulation shall fill the entire cavity, or an additional air barrier shall be installed inside the double wall or bump out and in contact with the insulation so that the insulation fills the cavity formed by the additional air barrier.
- The entire double wall or framed bump-out assemblies shall be constructed to be airtight regardless of additional air barriers installed internally to reduce the required volume of installed insulation.

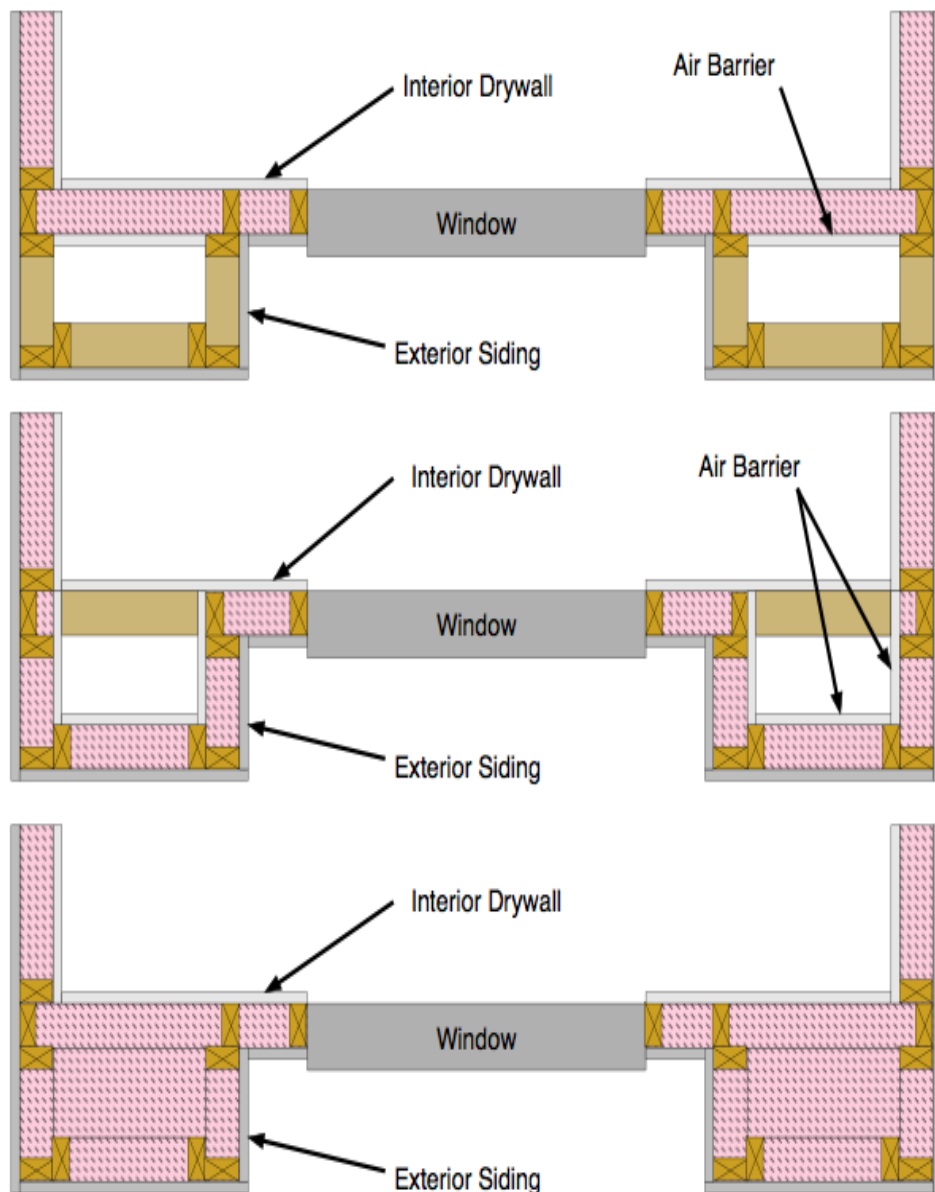

## Special Situations - Structural Bracing, Tie-downs and Steel Structural Framing

Reference: [RA3.5.X.2.8](#)

- Framing and bracing used for structural purposes shall be identified on plan documents with diagrams or design drawings. Reduced R-values for these locations shall be indicated on the CF1R.
- Insulation shall be installed in a manner that restricts thermal bridging through the structural framing assembly.
- Insulation shall be applied to fully enclose or adhere to all sides and ends of structural assembly framing that separate conditioned from unconditioned space.
- The structural portions of assemblies shall be air-tight.

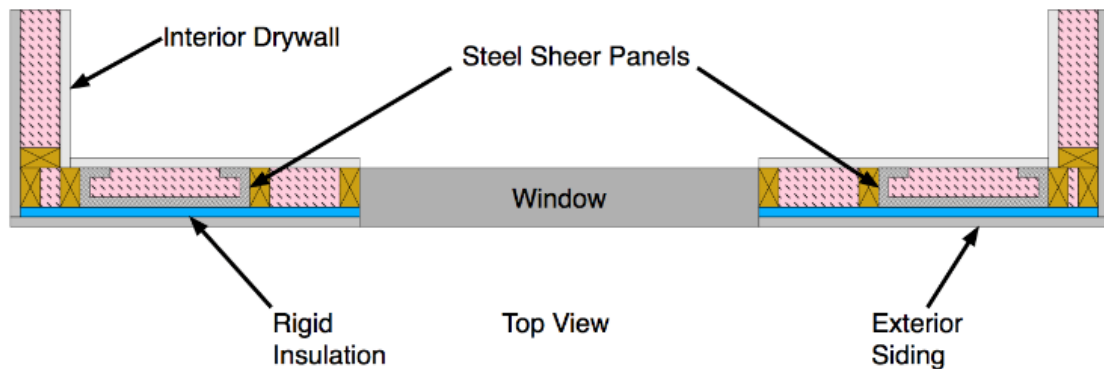

## Special Situations - Window and Door Headers

Reference: [RA3.5.X.2.9](#)

- All single-member window and door headers shall be insulated to a minimum of R-3 for 2x4 framing or R-5 for other assemblies.
- Insulation is to be placed between the interior face of the header and inside surface of the interior wall finish.
- No header insulation is required for single-member headers that are the same width as the wall, provided that the entire wall has at least R-2 insulation.

**Note:** The uninsulated header is allowed if exterior insulation is installed on the header alone or if continuous exterior insulation is installed, such is typically the case with an exterior stucco application.

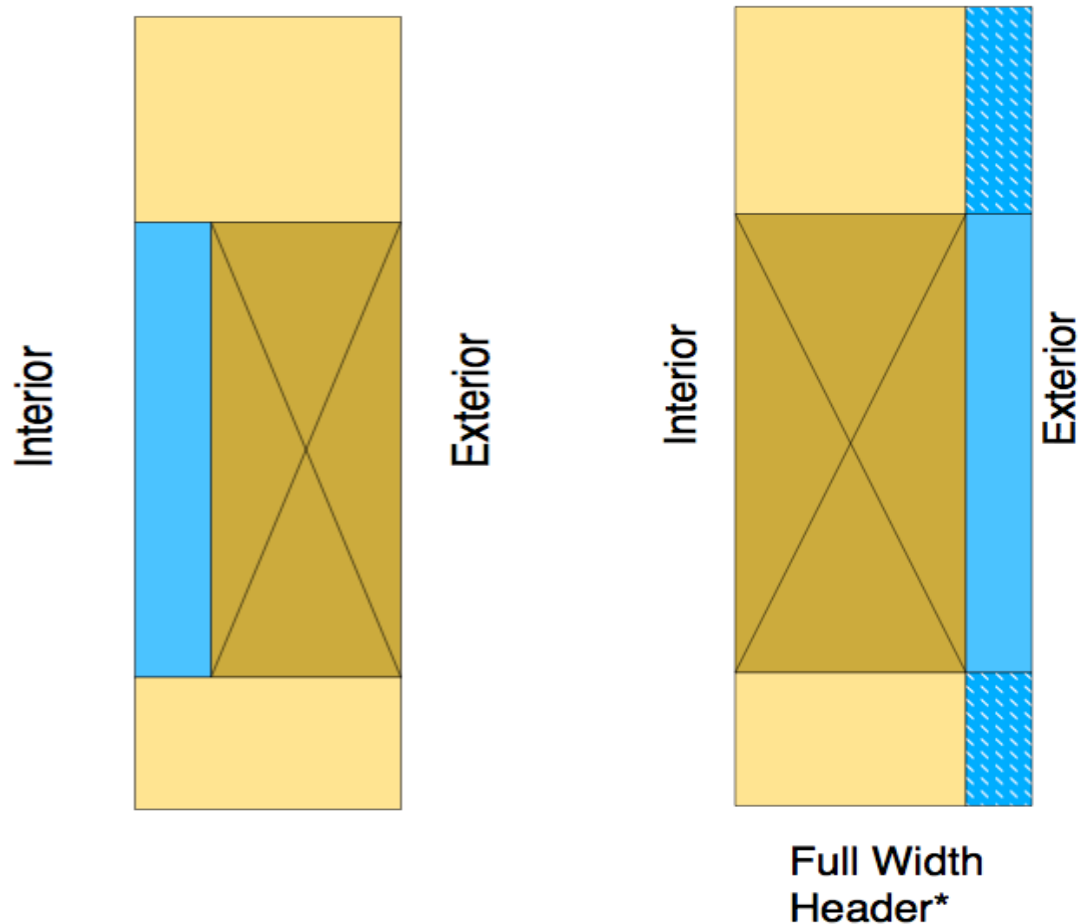



## 11. Specific Requirements for Roof/Ceilings

### Roof/Ceilings – Batt and Blanket Insulation

Reference: [RA3.5.3.3](#)

- Batt and blanket insulation shall be correctly sized to fit snugly at the sides and ends.
- Batt and blanket insulation shall be installed to be in contact with the air barrier.
- Where necessary, batt and blanket insulation shall be cut to fit properly - there shall be no gaps, nor shall the insulation be doubled-over or compressed.
- When batt and blanket insulation are cut to fit a non-standard cavity, they shall be snugly fitted to fill the cavity without compression.
- Batt and blanket insulation shall be cut to butt-fit around wiring and plumbing, or be split (delaminated) so that one layer can fit behind the wiring or plumbing, and one layer fit in front.
- Batt and blanket insulation that is thicker than framing depth shall be installed so that the insulation expands to touch adjacent insulation over each framing member.
- Baffles shall be placed at eaves or soffit vents of vented attics to keep insulation from blocking eave ventilation and prevent air movement under the insulation. The required net free-ventilation shall be maintained.

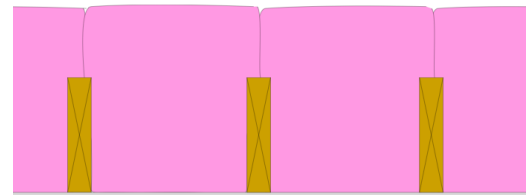
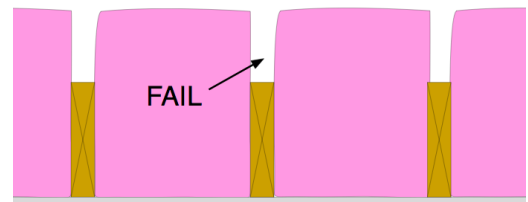

**Note:** It has been determined that it is virtually impossible to meet the QII requirements with **batts** in an attic ceiling with common roof **trusses** due to the gaps caused by the vertical truss cords.

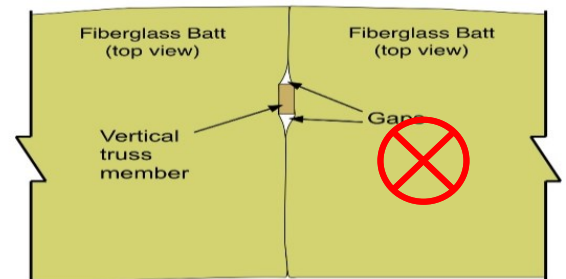
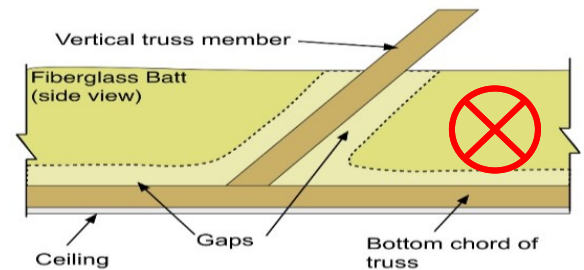

## Roof/Ceilings – Loose Fill Insulation

Reference: [RA3.5.4.3](#)



Attic rulers appropriate to the material shall be installed and evenly distributed throughout the attic to verify depth: one ruler for every 250 square feet and clearly readable from the attic access.

**Note:** The intent of this requirement is to make it as easy as possible for depth to be verified by the HERS Rater and building inspector. If rulers are not clearly visible from the attic access due to architectural constraints, work with the inspector and HERS Rater to come up with an alternative.

Attic rulers shall be scaled to read inches of insulation and the R-value installed. (Note that attic rulers are specific to each brand and type of installation and may not be interchanged).

- Insulation shall be applied underneath and on both sides of obstructions such as cross-bracing and wiring.
- Insulation shall be kept away from combustion appliance flues in accordance with flue manufacturer's installation instructions or labels on the flue.
- Insulation shall be blown to a uniform thickness throughout the attic with all areas meeting or exceeding the insulation manufacturer's minimum requirements for **depth and weight-per-square-foot**.



- The installer shall certify on the Certificate of Installation (CF2R) forms that the manufacturer's minimum weight per- square-foot requirement has been met.
- The HERS Rater shall verify that the manufacturer's minimum weight-per-square-foot requirement has been met for attics insulated with loose-fill fiberglass insulation only. See "*Cookie Cutter Test*".
- The HERS Rater shall verify that the manufacturer's minimum insulation thickness has been installed.



- For cellulose insulation, this verification shall consider the time that has elapsed since the insulation was installed. At the time of installation, the insulation shall be greater than or equal to the manufacturer's minimum initial insulation thickness. If the HERS rater does not verify the insulation thickness at the time of installation, and if the insulation has been in place less than fourteen days, the insulation thickness shall be greater than the manufacturer's minimum required thickness to achieve the given R-value at the time of installation, less 1/2 inch to account for settling. If the insulation has been in place for fourteen days or more, the insulation thickness shall be greater than or equal to the manufacturer's minimum required settled thickness to achieve the given R-value.

Loose fill insulation shall be applied all the way to the outer edge of the exterior wall's top plate.

**Note:** This may require an insulation dam where the attic extends over unconditioned space.

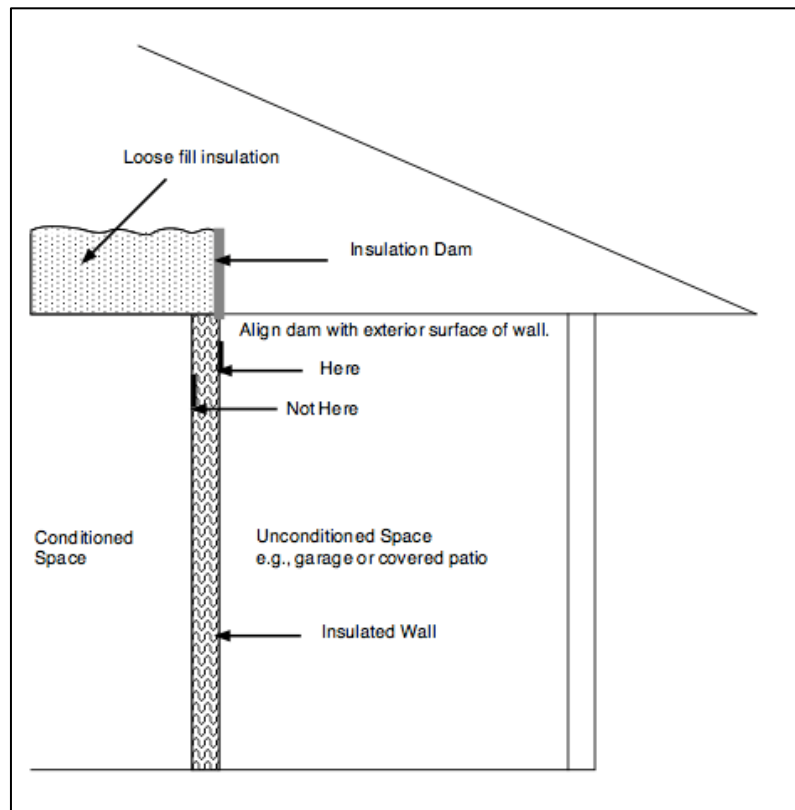

Loose fill extends all the way to the outside of the top plate. In a vented attic where eave baffles are installed, insulation should extend all the way to the baffle.

Because **cellulose** insulation is relatively dense and settles over time, this verification shall consider the time that has elapsed since the insulation was installed.

Refer to insulation manufacturer's specifications related to settling.

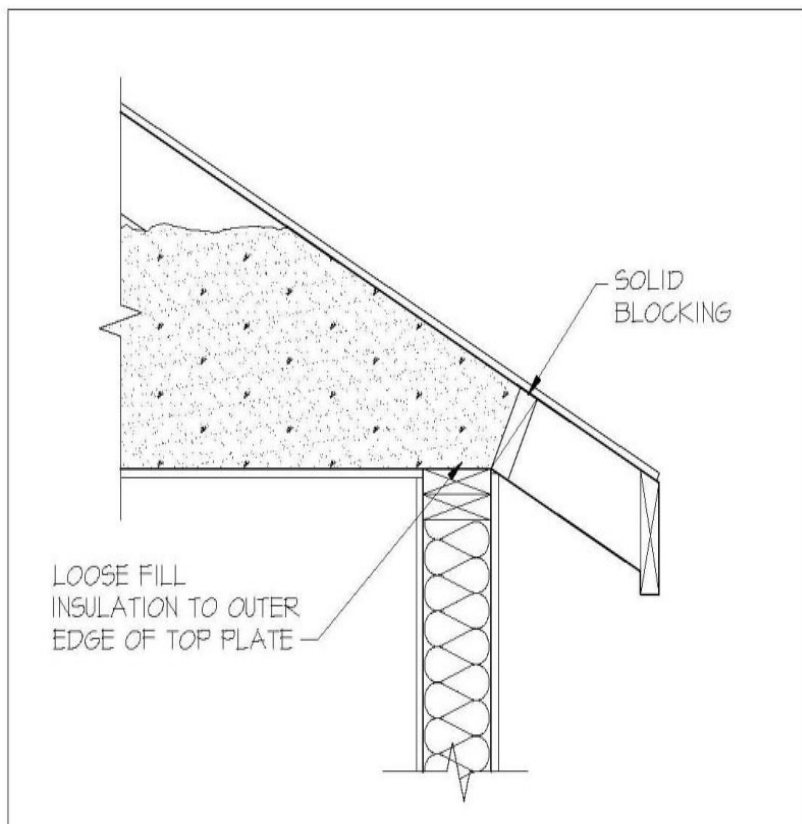



## Roof/Ceilings: **Rigid Insulation**

Reference: [RA3.5.5.3](#)

Rigid board insulation installed above the roof deck shall be applied (so that it extends) to the outer edge of the plane of the wall top plate.

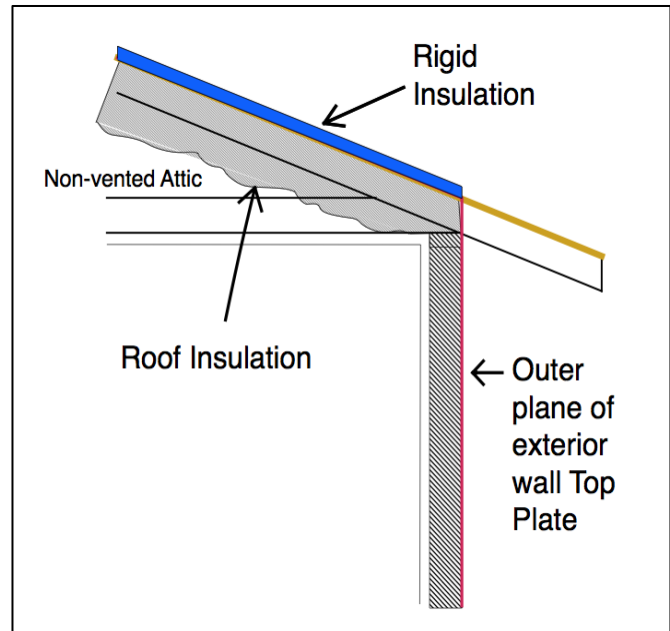

## Roof/Ceilings: **SPF Insulation**

Reference: [RA3.5.6.3](#)

SPF insulation shall be applied to fully adhere to the substrate of the ceiling or roof deck.

SPF insulation shall be applied to fully adhere to the joist and other framing faces to form a complete air seal within the construction cavity.

SPF insulation shall not be applied directly to recessed lighting fixtures unless the recessed fixture is rated for insulation contact (IC) appropriate for use with polyurethane spray foam in accordance with NEMA LE 7-2015.

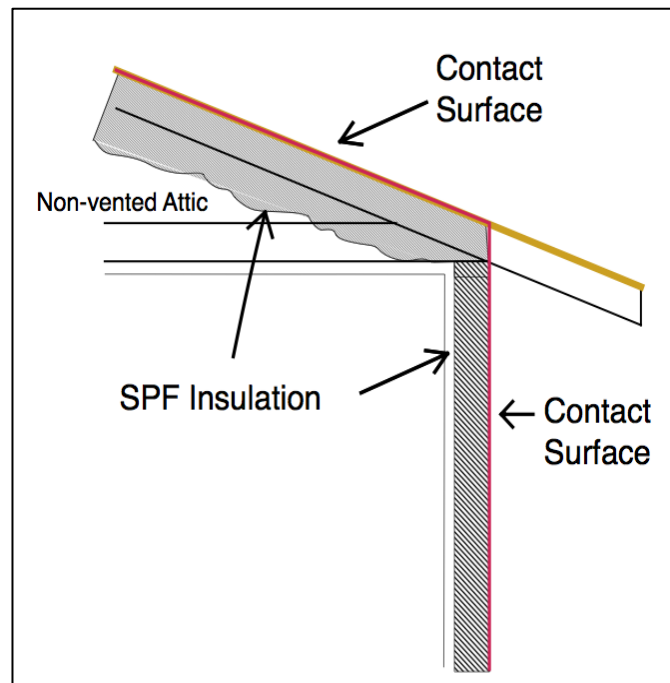



## Special Situations - Enclosed Rafter Ceilings

Reference: [RA3.5.X.3.1](#)

- In vented rafter ceilings, an air space shall be maintained between the insulation and roof sheathing per California Building Code, Sections 1203.2 and R806.3, or as specified by the local building department.
- Facings and insulation shall be kept away from combustion appliance flues in accordance with flue manufacturers' installation instructions or labels on the flue.

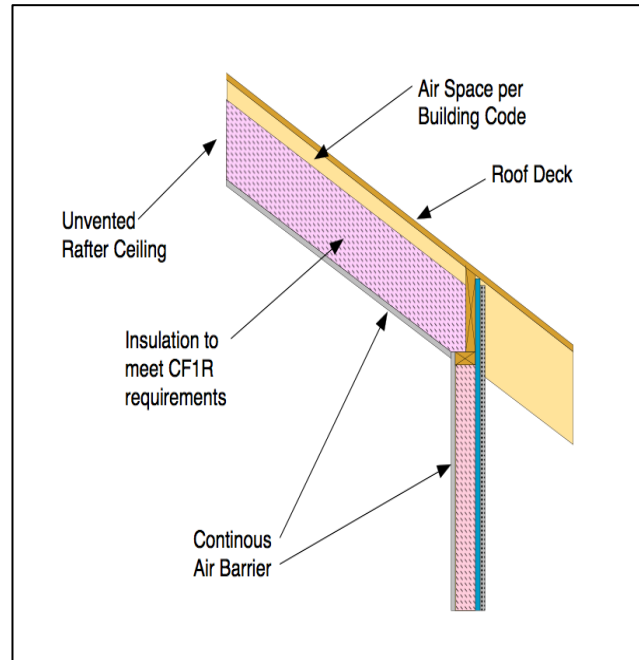

- Insulation installed in unvented rafter ceilings or to the underside of unvented roofs with an attic below shall have an R-value conforming to compliance documentation and the air barrier shall be uniform across the transition of roof to wall. The insulation shall be in contact with the air barrier.
- SPF insulation installed in unvented rafter ceilings or to the underside of unvented roofs with an attic below shall have an R-value conforming to compliance documentation and the air barrier shall be uniform across the transition of roof to wall. The insulation shall be in contact with the air barrier.

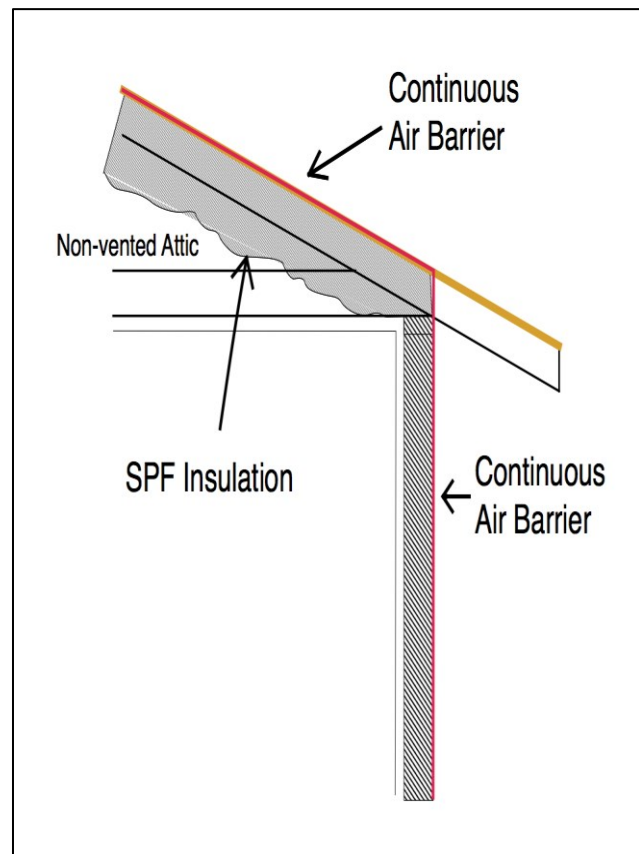

## Gable Ends in Unvented Attics

Reference: [RA3.5.X.2.10](#)

In unvented attics, where insulation is applied directly to the underside of the roof deck, framing for gable ends that separate the unvented attic from unconditioned space shall be insulated to meet or exceed the wall R-value of the adjacent exterior wall construction as specified on the Certificate of Compliance.

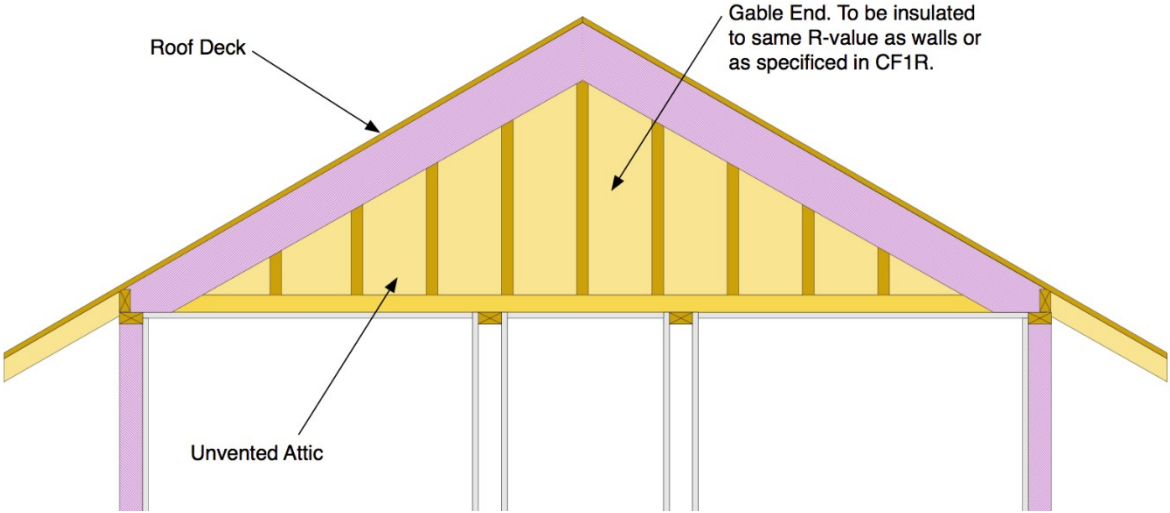

## Special Situations - HVAC Platform

Reference: [RA3.5.X.3.3](#)

It is very common for HVAC equipment to be located in the attic, directly above conditioned space. The mechanical code requires easy access to the equipment, this is usually accomplished by building a flat platform out of plywood or OSB. A typical platform size for a single furnace is about 5' x 10'. If it is not near the attic access code also requires a 3' wide "catwalk". The platform and catwalk are usually supported by a reinforced bottom cord of the roof trusses and are often only 6-8" above the ceiling sheetrock. This means that they may interfere with the ceiling insulation. If so, the area under the platform and catwalk needs to be modeled as having a lower R-value than the rest of the ceiling. This will be shown in the Opaque Surfaces section of the CF1R-PRF-01.

- Batt and blanket insulation shall be placed below any platform or cat-walk for HVAC equipment installation and access. (assuming vented attic)
- Batt and blanket insulation shall be installed so that they will be in contact with the air barrier.
- If SPF is used, a minimum of 3 inches of ccSPF insulation or 5.3 inches of ocSPF shall be placed below any platform or cat-walk access ways installed in vented attics for HVAC equipment or other needs.
- The overall assembly R-value shall meet the required R-values specified in the compliance documentation.

**Note:** If the platform is taller than the required height of the insulation, it does not need to be in contact with the insulation. The platform is not intended to be an air barrier.

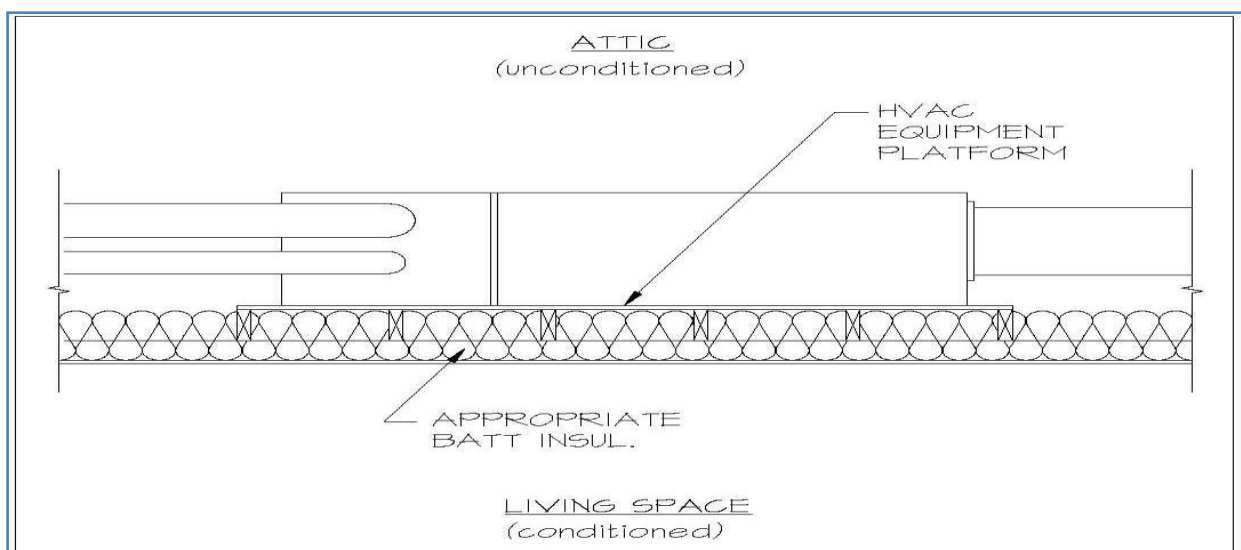

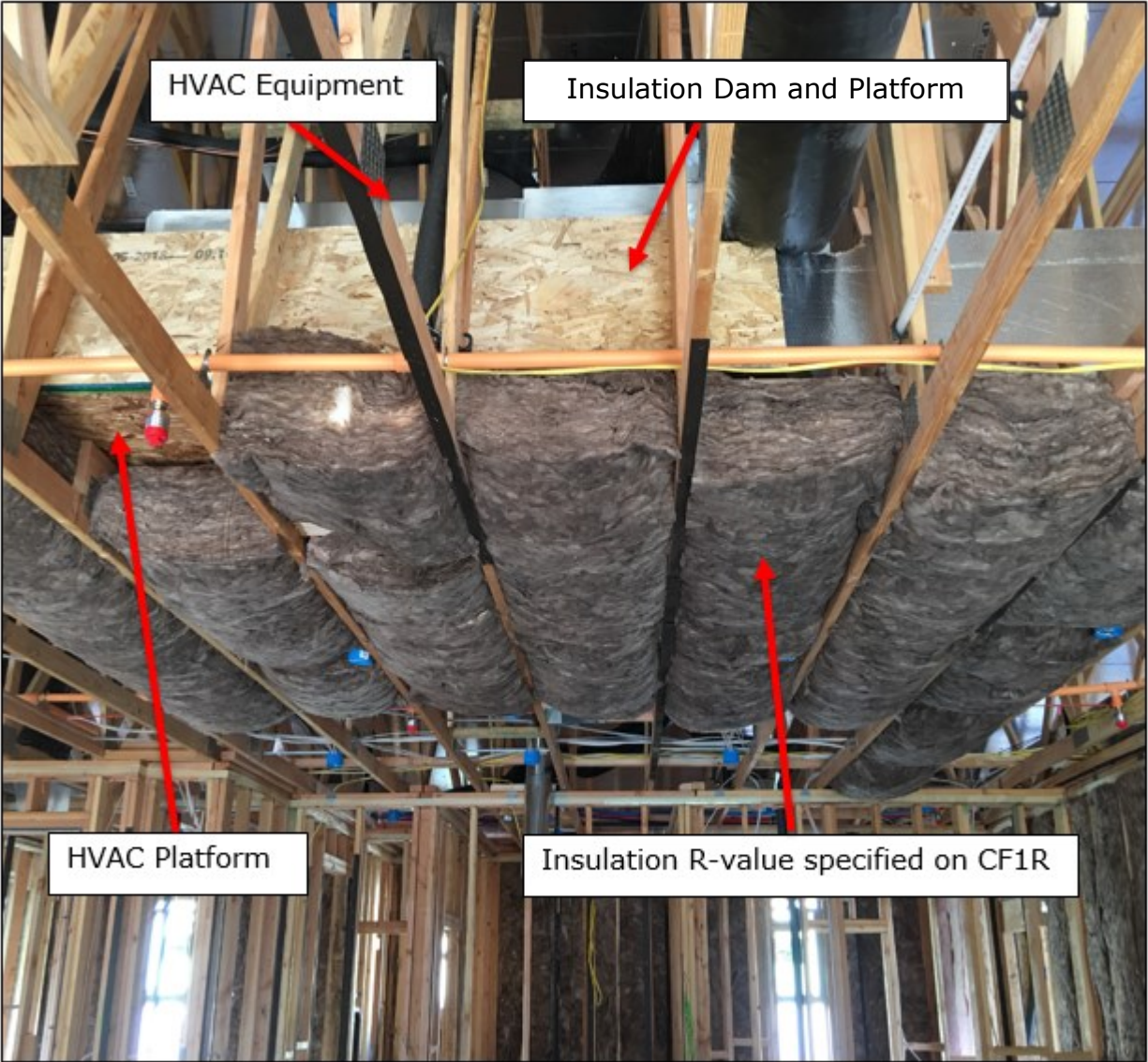



## Special Situations - Attic Access

Reference: [RA3.5.X.3.4](#)

- Permanently attach rigid board insulation or batt or blanket insulation with the appropriate R-value to the access door using adhesive or mechanical fastener.
- The bottom of the attic access shall be gasketed to prevent air leakage of conditioned air to the unconditioned attic.
- A minimum of 3 inches of ccSPF or 5.3 inches of ocSPF insulation shall be applied to the access door assuring good adhesion to the door surface.
- The overall assembly R-value shall meet the required values specified in the compliance documentation.

**Note:** For loose fill insulation, an insulation dam may be required to keep insulation from falling into the access hole and maintaining the minimum insulation depth. Insulation should not be tapered near the access.

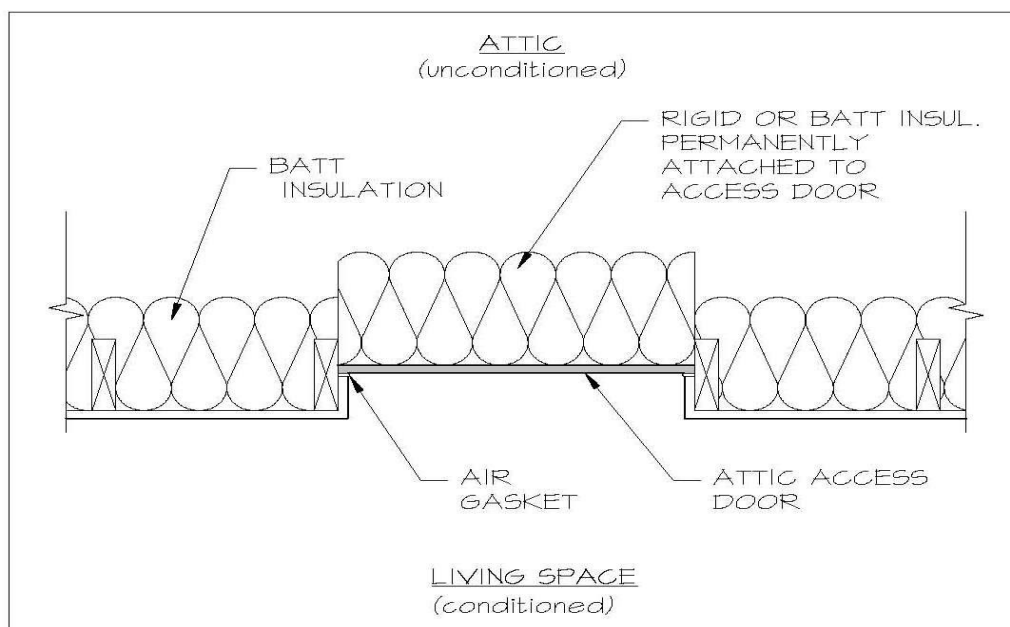





Attic access cover insulated with fiberglass batt. Notice the straps holding insulation in place.

This diagram below demonstrates the use of rigid foam on the attic access door. This is a much better application as the foam can be glued to the cover. The photo above shows yellow straps holding the batt insulation to the cover. Applying glue to a paper faced batt will not withstand the test of time.

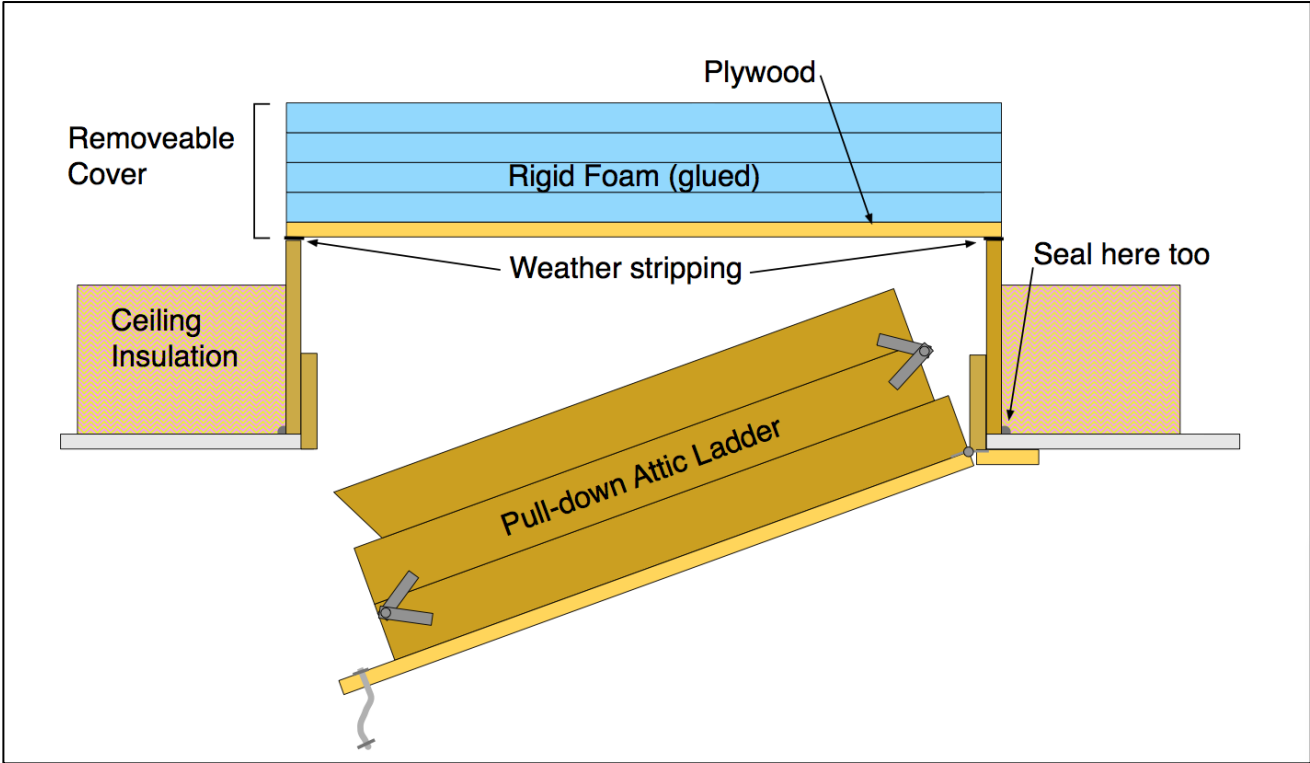

## 12. Raised Floors

Reference: [3.5.X.4](#)

- Batt and blanket insulation shall be correctly sized to fit snugly at the sides and ends.
- Batt and blanket insulation shall be cut to fit properly without gaps.
- Insulation shall not be doubled-over or compressed.
- Batt and blanket insulation shall be in contact with the air barrier - usually the subfloor.
- SPF insulation shall be spray-applied to fully adhere to the bottom side of the floor sheathing.

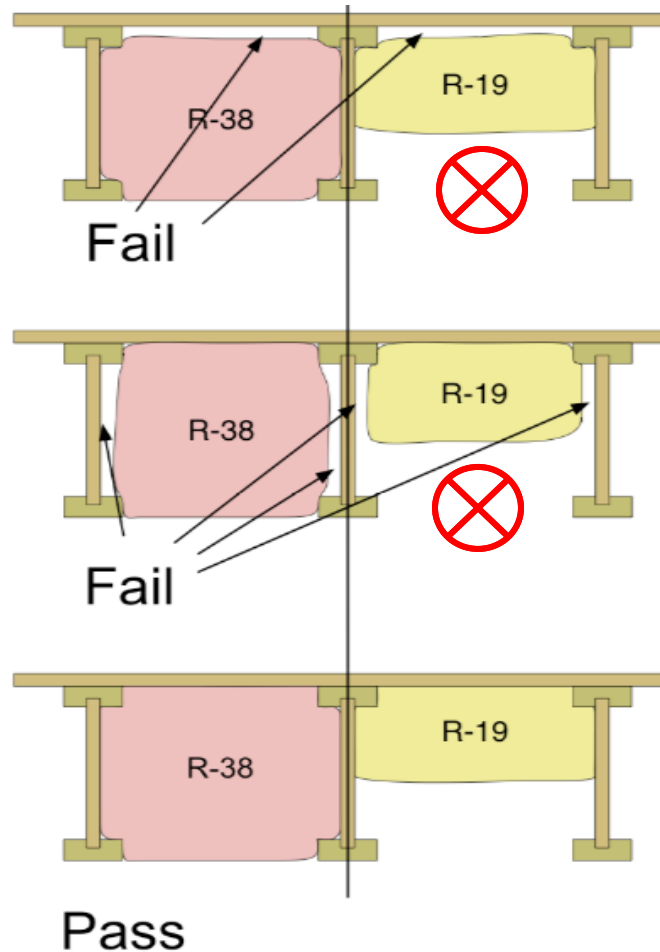

**Note:** "TJI" floor joists pose a particular problem for batt insulation. Make sure that the batts are in contact with the subfloor and are full width batts so that they expand into the side pockets created by the I-beam shape of the joists



## Homes with Conditioned Space over a Garage

Reference: [RA3.5.X.4.2](#)

- The separation between conditioned space (house) and the garage shall be insulated to create a continuous thermal barrier.
- All rim and band joists adjoining conditioned space shall be air tight and insulated.

### SPF:

- The floor over the garage shall be insulated by spraying SPF insulation to fully adhere to the subfloor of the conditioned space.
- The garage and the adjacent conditioned space (house) shall be insulated up to the subfloor.
- SPF insulation shall cover any gaps between the header and the floor joist.

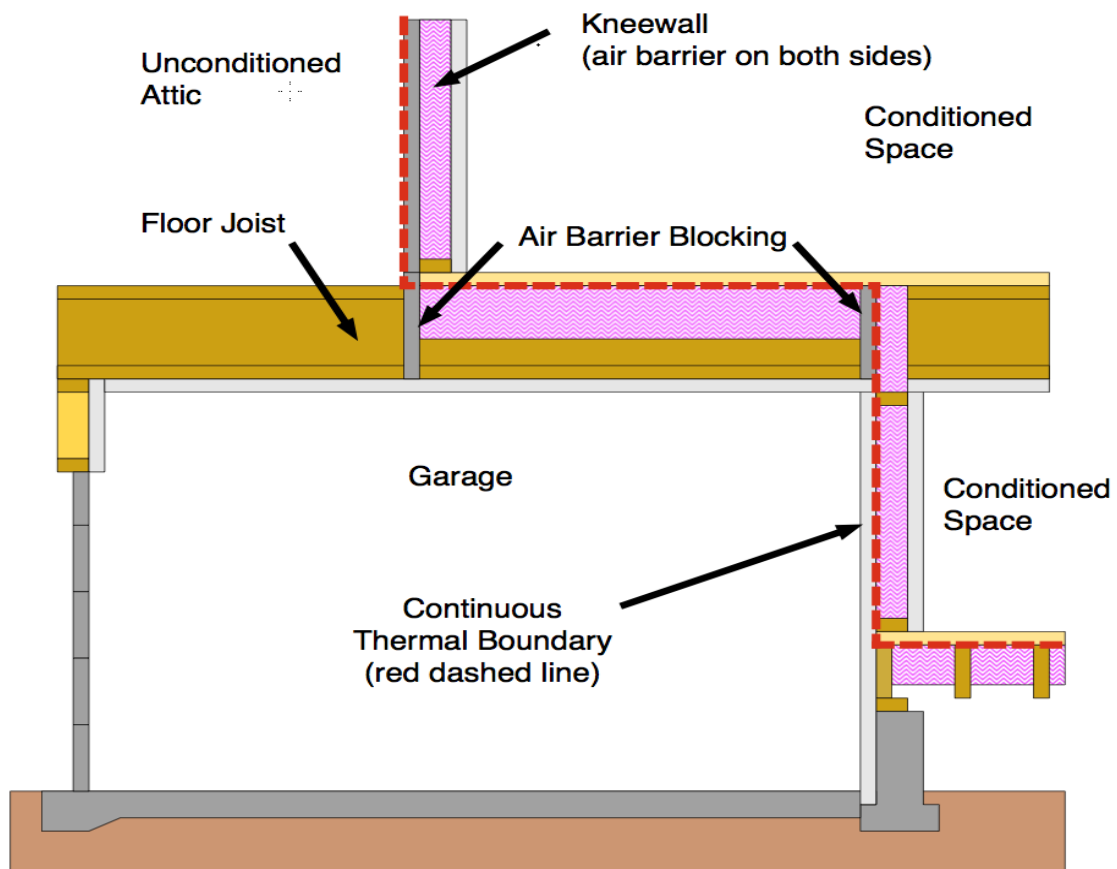

Option 1

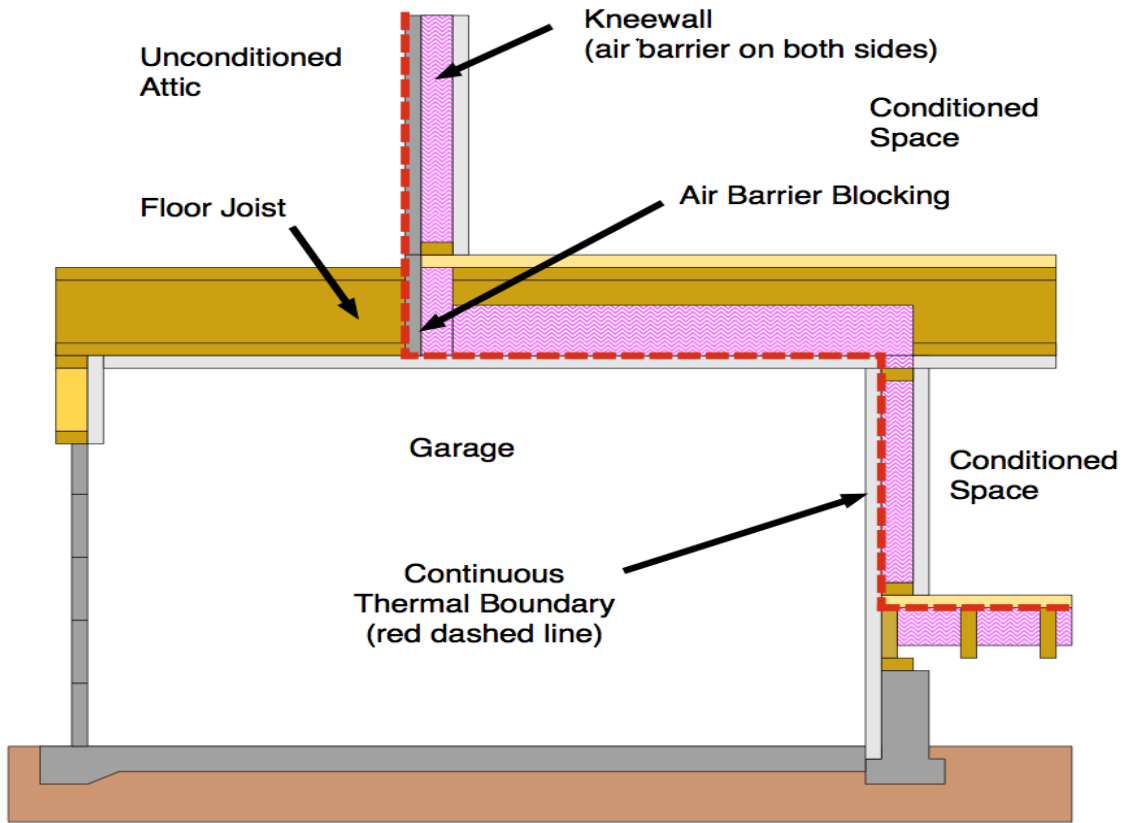

Option 2

## Homes with Unconditioned Space over a Garage

Reference: [RA3.5.X.4.3](#)

The band joist where the garage transitions to an attic above conditioned space shall have an air barrier installed in contact with the edge of the attic insulation.

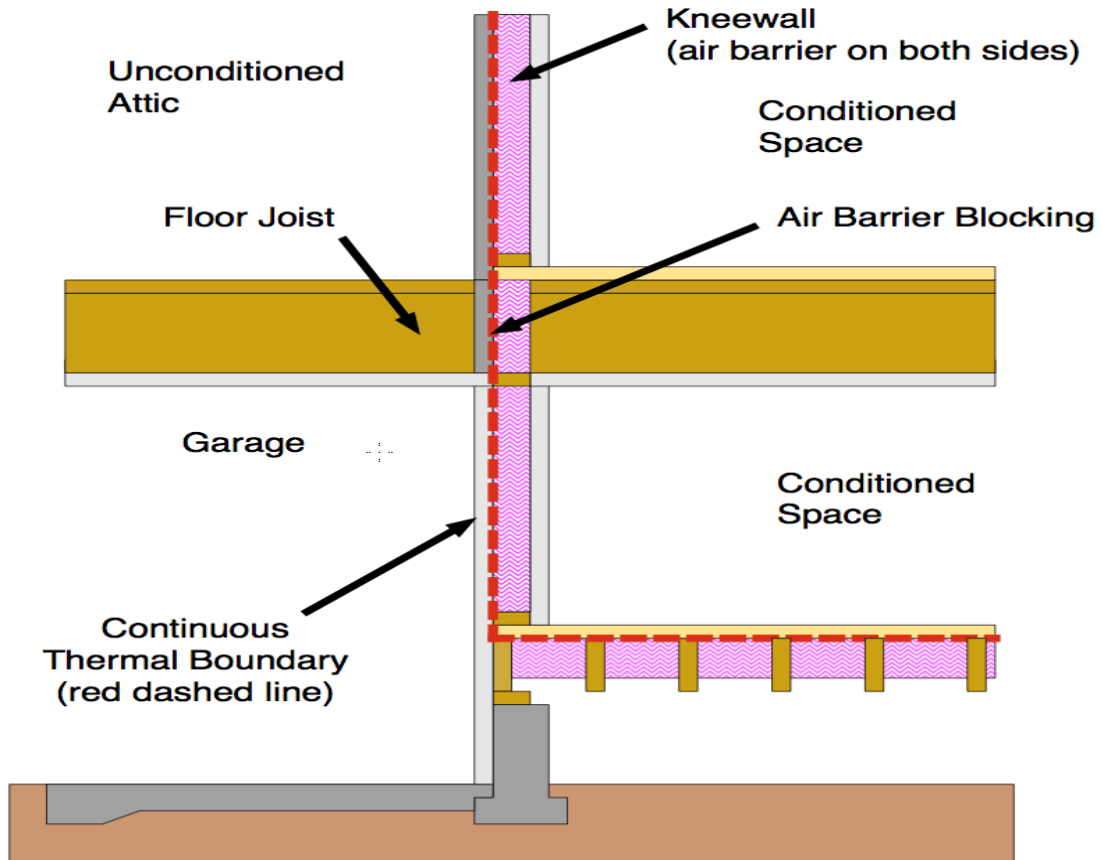



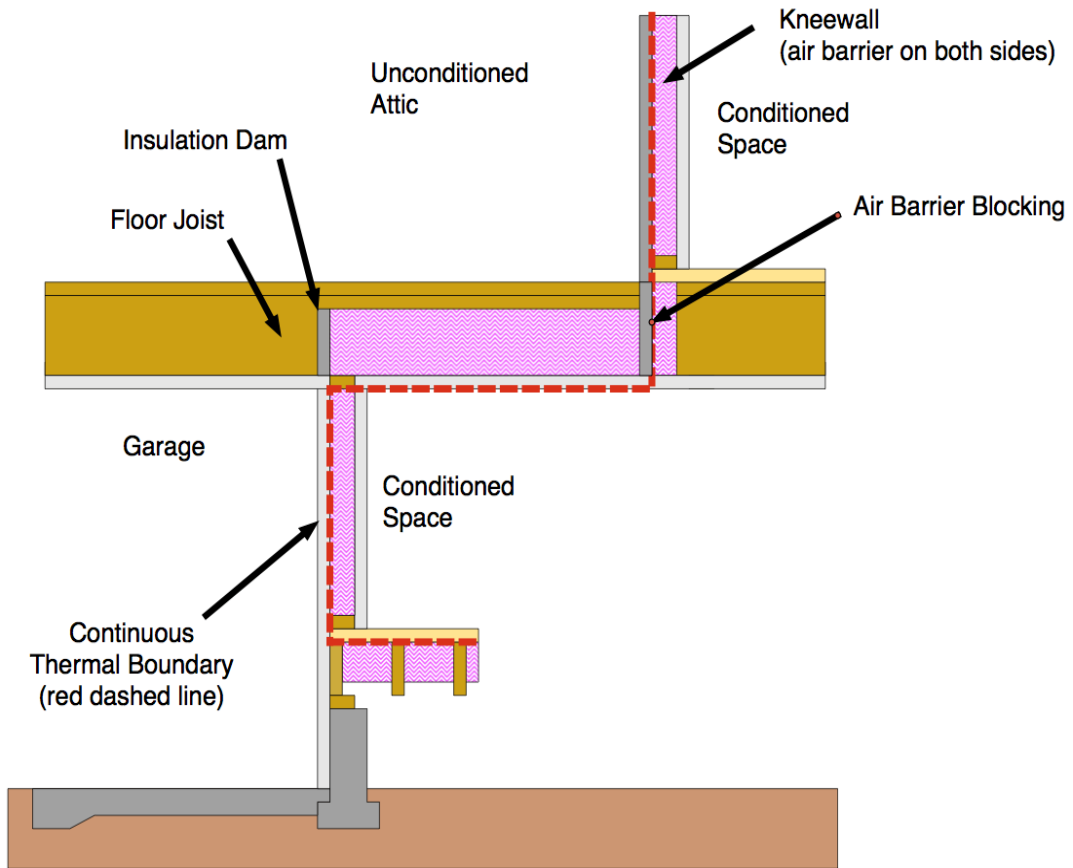

## The “Cookie Cutter” Test

The HERS Rater should verify that the manufacturer’s minimum weight-per-square-foot requirement has been met for attics insulated with loose fill mineral-fiber insulation (not cellulose). Verification should be determined using the methods of the *Insulation Contractor’s Association of America (ICAA) Technical Bulletin #17* (attached) except that only one sample should be taken in the area that appears to have the least amount of insulation. The HERS Rater should record the weight-per-square-foot of the sample on the CF3R.

### Procedure

1. Carefully work the sampling tool, also called a cookie cutter, down into the insulation to get a full depth sample. Avoid electrical wiring, plumbing, framing and other obstructions.
2. Remove all the insulation from within the sampling tool and place it into a plastic bag.
3. Weigh the bag of insulation; subtract the weight of the bag from the sample weight.
4. Divide the weight of the sample in pounds by the area of the cookie cutter in square feet.
5. Perform the cookie cutter density calculation (example is provided below).
6. The measured weight per square foot, or density, must be greater than the manufacturer’s specification required to achieve the target R-value on the Certificate of Compliance (CF1R).
7. Replace the insulation and fluff it back up as best as you can.



## Cookie Cutter Density Calculation Example

A HERS rater performs a "cookie cutter test" on the ceiling insulation in a newly constructed home. If the weight of the blown-in insulation is 9.7 ounces and the diameter of the sampling tool is 12 inches, what is the "density" of the sample in pounds per square feet (lbs. /sq.ft.)?

In this example, we are trying to determine the "density" of the sample in pounds per square feet, which is listed as (lbs. /sq. ft).

The information in this example was:

1. Using a 12-inch cookie cutter tool.
2. The weight of the blown-in insulation is 9.7 ounces.

**Example:** Measured lbs. /sq. ft. = (9.7 oz./16) / 0.785 sq.ft. = .772 lbs./sq.ft.

## Calculation Worksheet for "Cookie Cutter" Test

Diameter of Cookie Cutter in inches (circle one)	10	→	0.545	Area (sqft)	Enter area below
	12	→	0.785		
	14	→	1.069		
	16	→	1.396		
	13.54	→	1.000		
<b>Measured</b> Weight of Sample (ounces)	<input type="text"/>		ounces		
Divide ounces by 16	÷	16			
to get lbs	=		lbs		
Divide lbs by sqft	÷				
to get <b>Measured</b> lbs/sqft	=		lbs/sqft		
			greater than?	If yes, pass.	<input type="text"/> Pass <input type="text"/> Fail
<b>Target</b> lbs/sqft (from manufacturer)	<input type="text"/>		lbs/sqft		
(Typical targets range from 0.300 to 0.800 lbs/sft, depending on R-value and brand.)					

## 13. The QII Checklists

The HERS Rater will perform their QII inspections with the help of CF3R checklists. The CF2R forms used by the installers have these same checklist items also. It is very important that the installer know exactly what the Rater will be looking for. For that reason, these QII checklists will provide guidance. Each item on the checklist is cross referenced with a section of this document for additional detail.

### QII Checklist 1

#### CF3R-ENV-21 QII AIR INFILTRATION SEALING – FRAMING STAGE

##### A. Air Barrier Materials

- 1) A continuous sealed exterior air barrier is required in all thermal envelope assemblies to limit air movement between unconditioned/outside spaces and conditioned/inside spaces, and must comply using one of the following methods
- 2) Using assemblies of materials and components that have an average air leakage not to exceed 0.04 cfm/ft<sup>2</sup> under a pressure differential of 0.3 in. w.g. (1.57 pcf) (0.2 L/s.m<sup>2</sup> at 75 pa) when tested in accordance with ASTM E2357, ASTM E1677, ASTM E1680, or ASTM E283; or
- 3) Testing the complete building and demonstrating that the air leakage rate of the building envelope does not exceed 0.40 cfm/ft<sup>2</sup> at a pressure differential of 0.3 in. w.g. (1.57 pcf) (2.0 L/s.m<sup>2</sup> at 75 pa) in accordance with ASTM E779 or an equivalent approved method.

**Note:** *SPF insulation is an acceptable air barrier and sealant when installed to a minimum thickness of 2 inches for closed cell and 5.5 inches for open cell, except where not allowed by manufacturer (e.g., flues, vents, can lights, etc.).*

##### B. Raised Floor Adjacent to Unconditioned Space or Separate Dwelling Units

- 1) All gaps in the raised floor are sealed.
- 2) All chases are sealed at floor level using a sealed hard cover.
- 3) All holes (e.g., for plumbing and electrical wires) that penetrate the floor or bottom plates of walls are sealed.
- 4) Subfloor sheathing is glued or sealed at all panel edges to create a continuous air tight subfloor air barrier.

### **C. Walls Adjacent to Unconditioned Space**

- 1) All penetrations through the exterior wall air barrier are sealed to provide an air tight envelope to unconditioned spaces such as the outdoors, attic, garage, and crawlspace.
- 2) Exterior wall air barrier is sealed to the top plate and bottom plate in each stud bay.
- 3) All electrical boxes, including knockouts, which penetrate the air barrier to unconditioned space are sealed.
- 4) All openings in the top and bottom plate, including all interior and exterior walls, to unconditioned space are sealed; such as holes drilled for electrical and plumbing.
- 5) Exterior bottom plates (all stories) are sealed to the floor.
- 6) All gaps around windows and doors are sealed. The sealant used follows manufacturer specifications.
- 7) Rim joist gaps and openings are fully sealed.
- 8) Fan exhaust duct outlet/damper at the exterior wall are sealed.
- 9) Knee walls have solid and sealed blocking at the bottom, top, left and right sides to prevent air movement into insulation.

### **D. Ceiling Air Barrier Adjacent to Unconditioned Space**

- 1) There is a continuous air barrier at the ceiling level. All openings into walls, drops, chases or double walls are sealed.
- 2) All penetrations through the top plate of interior and exterior walls are sealed.
- 3) Fire sprinklers penetrating a ceiling air barrier shall be sealed to prevent air movement according to the manufacturer's instructions.
- 4) All fixtures cut into ceiling air barrier (e.g., HVAC registers, electrical boxes, fire alarm boxes, exhaust fan housing, and recessed lighting fixtures) are sealed to the surrounding dry wall. If it is not possible to seal the fixture directly, a secondary air barrier shall be created around the fixture.
- 5) All installed recessed lighting fixtures that penetrate the ceiling to unconditioned space are rated to be Insulation Contact and Airtight (IC and AT) which allow direct contact with insulation.
- 6) All dropped ceiling areas are covered with hard covers that are sealed to the framing, or else the bottom and sides of dropped ceiling areas are all insulated and sealed as ceilings and walls as required on the Certificate of Compliance.
- 7) All vertical chases (e.g., HVAC ducts and plumbing) and soffits are sealed at the ceiling level.



- 8) Chimneys and flues require sheet metal flashing at the ceiling level. The flashing shall be sealed to the chimney/flue with fire rated caulk. The flashing shall be sealed to the surrounding framing.
- 9) Framing locations where air may move down into the walls from the attic (e.g., double walls, pocket doors, architectural bump-outs, etc.) have a sealed hard cover to prevent air movement.
- 10) Attic access forms an airtight seal between the conditioned space and unconditioned space. Vertical attic access requires mechanical compression using screws or latches.

#### **E. Roof Air Barrier – Unvented Attics Adjacent to Unconditioned Space**

- 1) There is a continuous air barrier at the roof deck and gable ends.
- 2) Chimneys and flues require sheet metal flashing at the roof deck. The flashing is sealed to the chimney/flue with fire rated caulk. The flashing is sealed to the surrounding framing.
- 3) All penetrations in the roof deck and gable ends for plumbing, electrical, etc. are sealed.

#### **F. Conditioned Space Above or Adjacent to Garage Air Barrier**

- 1) All penetrations in the subfloor above the garage into conditioned space must follow the raised floor air barrier requirements.
- 2) Infiltration between the space above the garage and the subfloor is prevented by one of the following methods:
  - Seal all edges of the garage ceiling (typically drywall) at the perimeter of the garage to create a continuous air tight surface between the garage and adjacent conditioned envelope. Seal all plumbing, electrical, and mechanical penetrations between the garage and adjacent conditioned space. For an open-web truss, airtight blocking is added on all four sides of the garage perimeter. Insulation can be placed on the garage ceiling.
  - Seal the band joist above the wall at the garage to conditioned space transition. Seal all subfloor seams and penetrations between the garage and adjacent conditioned space. Insulation must be placed in contact with the subfloor below the conditioned space.

#### **G. Cantilevered Floor Air Barrier**

- 1) Airtight blocking is installed between joists where the wall rim joist would have been located in the absence of a cantilever.
- 2) Exterior sheathing is installed to the bottom of the cantilever so that there is a continuous air and weather barrier for the cantilever. The cantilevered joist must be insulated to the same R-value as would be required for the subfloor prior to closing.

- 3) Any gaps, cracks or penetrations in the air barrier of the cantilever are sealed. Recessed can lights in the cantilever are IC and AT and properly sealed to the sheathing.

#### **H. Walls for Attached Porch, Attic, Double Wall Barrier**

- 1) An exterior wall air barrier is required at the intersection of the porch and exterior wall when there is conditioned space on the other side. The exterior wall includes an air barrier where the attic attaches to the conditioned space.
- 2) Truss framing blocking is used at the top and bottom of each wall/roof section.

#### **I. Air Barriers in Multifamily Dwellings**

- 1) Each dwelling unit must be sealed to stop air movement between dwelling units. Treat adjacent dwelling units as unconditioned space for air sealing.
- 2) All penetrations through the floor and ceiling of each dwelling unit are sealed, including electric and gas utilities, water pipes, drain pipes, fire protection service pipes, and communication wiring.
- 3) Elevator penthouse, mechanical penthouse, stairwell doors, roof access hatches, and plumbing stacks that separate conditioned and unconditioned space are all sealed.
- 4) Vertical chases for garbage chutes, elevator shafts, HVAC ducting and plumbing shall be treated as unconditioned space for sealing.
- 5) Common hallways shall be treated as unconditioned space for sealing.

#### **J. Special Requirements for SIP's**

- 1) SIPs are considered an air barrier when properly sealed at top, bottom, sides and all penetrations.
- 2) Air barrier is continuous across all surfaces, including between SIPs and non-SIP sections.

#### **K. Special Requirements for ICF's**

- 1) ICF sections are considered an air barrier when properly sealed at top, bottom, sides and all penetrations.
- 2) Air barrier is continuous across all surfaces, including between ICF and non-ICF sections.

#### **L. Determination of HERS Verification Compliance**

All applicable sections of this document shall indicate compliance with the specified verification protocol requirements in order for this Certificate of Verification as a whole to be determined to be in compliance.

## QII Checklist 2

### CF3R-ENV-22 QII – INSULATION INSTALLATION

#### A. Insulation Materials Installed

- 1) Roof Deck Insulation Material Installed.
- 2) Ceiling Insulation Material Installed.
- 3) Exterior Wall Insulation Material Installed.
- 4) Raised Floor Insulation Material Installed.
- 5) Slab Edge Insulation Material Installed.

#### B. All Surfaces

- 1) Air barrier installation and preparation for insulation was done and verified prior to insulation being installed.
- 2) All surfaces between conditioned and unconditioned space are sealed and insulated to meet or exceed the levels specified on the Certificate of Compliance
- 3) All structural framing areas shall be insulated in a manner that resists thermal bridging through the assembly separating conditioned from unconditioned space. Structural bracing, tie-downs, and framing of steel, or specialized framing used to meet structural requirements of the CBC are allowed and must be insulated. These areas shall be called out on the building plans with diagrams and/or specified design drawings indicating the R-value of insulation and fastening method to be used.
- 4) All insulation was installed according to the manufacturer's installation instructions.
- 5) Labels or specification/data sheets for each insulation material shall be provided to the HERS rater. Loose-fill material includes insulation material bag labels or coverage charts.
- 6) Loose-fill insulation – The installed depth and density of insulation is verified in at least 6 random locations to ensure that the minimum thickness and installed density meet the R-value specified on the Certificate of Compliance, and are consistent with the manufacturer's coverage chart.
- 7) If kraft paper faced insulation is used, paper is installed on the conditioned (warm in winter) side of surface. Paper must be in contact with air barrier to within 2" framing (stud, joists, etc.).

**C. Raised Floor Adjacent to Unconditioned Space**

- 1) Insulation is in full contact with the subfloor.
- 2) Insulation hangers are spaced at 18 inches or less. Insulation hangers do not compress insulation.
- 3) Netting, or mesh, can be used if the cavity under the floor is filled and in contact with the subfloor.
- 4) When daylight basements are adjacent to crawlspaces, if the basement is conditioned, the walls adjacent to the crawlspace are insulated to the R-value listed on the Certificate of Compliance. This includes framed stem walls, and vertical concrete retaining walls.
- 5) If access to the crawlspace is from the conditioned area the raised floor includes an airtight insulated access hatch. Where possible locate crawl space access on the exterior.

**D. Wall Adjacent to Unconditioned Space**

- 1) Insulation quality was verified prior to the installation of the interior air barrier (typically gypsum board).
- 2) Loose-fill and batt insulation is in contact with all six sides of wall cavities (top, bottom, back, left, right, front [to be installed later]) with no gaps, voids or compression. Exception: Where framing depth is greater than minimum required insulation thickness (e.g., R-19 batts in 2x10 walls). All electrical boxes, including knockouts, that penetrate the air barrier to unconditioned space are sealed.
- 3) Insulation fits snugly around obstructions (e.g., electrical boxes, plumbing and wiring) with no gaps, voids or compression.
- 4) Structural metal tie-downs and shear panels are insulated between exterior air barrier and metal.
- 5) Hard to access wall stud cavities, such as corner channels or wall intersections, are insulated to the proper R-value prior to the installation of exterior sheathing or exterior stucco lathe.
- 6) Insulation and interior air barrier are installed behind tub, shower, fireplace enclosures and stairwells to the R-value listed on the Certificate of Compliance when located against exterior walls.
- 7) All single-member window and door headers shall be insulated to a minimum of R-3 for a 2x4 framing, or equivalent width, and a minimum of R-5 for all other assemblies. If continuous exterior rigid insulation equal to or greater than R-2 is used, an insulated header is not required.
- 8) After insulation is installed: All insulated walls have interior and exterior air barriers, including kneewalls and walls of skylight wells. Exception: Rim joists. Interior air barrier (typically gypsum board) is sealed to top plate.

**E. Ceiling Adjacent to Unconditioned Space**

- 1) Insulation extends to the outside surface of the exterior wall.
- 2) Insulation is in direct contact with the ceiling air barrier so there are no gaps, voids or compression.
- 3) Fire Chimneys and flues (except zero clearance) have a sheet metal collar at the ceiling level to prevent contact with the insulation. The collar is at least as tall as the depth of the insulation. There is a minimum 1" clearance between the collar and the chimney/flue for double wall vent, and 6" for single wall vent, unless manufacturer's instructions require otherwise. The collar is sealed to the ceiling with high temperature sealant to prevent air leakage. The insulation is in contact with the sheet metal collar.
- 4) Recessed can lights penetrating the ceiling air barrier are covered with insulation to the depth needed to meet the ceiling R-value specified on the Certificate of Compliance.
- 5) External surfaces of steel studs, steel-framed kneewalls, skylight shafts, and gable ends are covered with insulation.

**F. Ceiling Insulation in Vented Attics**

- 1) Required eave ventilation shall not be obstructed. The net-free ventilation area of the eave vent is maintained.
- 2) Eave vent baffles and dams are installed to prevent air movement under or into the ceiling insulation.
- 3) Attic access is insulated to the same R-value required by the Certificate of Compliance for ceiling insulation and the insulation is permanently attached using adhesive or mechanical fasteners.
- 4) Attic access must have a dam around the access to at least the same depth as the insulation.
- 5) Attic rulers specified to the installed loose-fill material (brand and type) are installed and evenly distributed throughout the attic to verify depth (one ruler for every 250 ft<sup>2</sup>). The rulers are clearly readable and scaled to read inches of insulation and the R-value installed.

**G. Insulation in Unvented Attics**

- 1) The roof sheathing is the air barrier and is sealed to prevent air movement to the outside.
- 2) Insulation is in full contact with the air barrier (roof sheathing).
- 3) If insulated using air permeable insulation, gable end walls are sealed and insulated the same as exterior walls, including interior air barrier.



**H. Insulation in Vented Attics (High Performance Vented Attics)**

- 1) Insulation is in full contact with roof sheathing and firmly supported to prevent sagging
- 2) Batt insulation between roof trusses is acceptable with minimal gaps and voids caused by roof truss members.
- 3) Insulation is not required on gable end walls.
- 4) Required roof deck insulation over any conditioned space, or HVAC ducts, is installed on the entire attic roof deck; even over unconditioned spaces (e.g., garage, covered porch). Roof deck of attic over unconditioned space without HVAC ducts and separated from other attics by a sealed air barrier do not need to be insulated.

**I. Special Requirements for Skylight Shafts and Attic Knee Walls**

- 1) Insulation must meet all the requirements for walls and insulation is in contact with the air barrier on all six sides unless SPF is used.
- 2) Insulation shall be in full contact with the interior wall finish. Batt insulation must be cut to fit around 2x4's that are laid flat.
- 3) Skylight shafts and attic knee walls shall be completely enclosed by vertical and horizontal framing, including horizontal plates at the top and bottom of the insulation.

**J. Special Requirements for Floors Above Garages**

- 1) If the air barrier is at the perimeter of the garage below the conditioned subfloor, then the insulation may be placed on the garage ceiling. The perimeter of the subfloor must also be insulated.

**K. Special Requirements for Cantilevered Floors**

- 1) Sealed blocking shall be installed between joists where the wall rim joist would have been located in the absence of a cantilever. Insulation shall be placed on both sides of the block.

**L. Special Requirements for Attached Porches**

- 1) Exterior wall at the intersection of the porch roof is fully insulated above, below and behind the roof line.
- 2) Where truss framing is used, airtight blocking is used at the top and bottom of each wall/roof section and is insulated.

**M. Special Requirements for SPF Insulation**

- 1) Installed product meets the claimed R-value per inch. Non-standard values are supported by an ICC Evaluation Service Report (ESR) number (e.g., ESR-xxxx) and documented on the CF2R-ENV-03. Non-standard values are anything greater than R-5.8/inch for closed cell and R-3.6/inch for open cell.
- 2) Installed thickness meets the required R-value from the Certificate of Compliance. Verified in at least 6 random places for each surface type: floors, walls, and ceilings.
- 3) Insulation is spray applied to fully adhere to structural assembly framing, floor and ceiling joists, and other framing surfaces within the construction cavity.
- 4) If multiple layers are applied, each foam lift (e.g., spray application) adheres to the substrate and foam interfaces.
- 5) Closed cell SPF: In areas where an air barrier is required the foam is at least 2" thick.
- 6) Open cell SPF: In areas where an air barrier is required the foam is at least 5.5" thick.
- 7) Open cell SPF: Depressions in the foam insulation surface are not greater than 1/2" of the required thickness provided these depressions do not exceed 10% of the surface area being insulated.
- 8) Open cell SPF: Insulation completely fills cavities of 2x4 framing.
- 9) SPF insulation is not applied directly to recessed lighting fixtures unless specifically allowed by manufacturer's instructions. When not allowed, can lights are:
  - A. Covered with a minimum of 1.5" of mineral fiber insulation; or
  - B. Enclosed in a manufacturer's approved box fabricated from an approved material, such as 18-gauge sheet metal or 1/2" gypsum board.

**N. Determination of HERS Verification Compliance**

- 1) All applicable sections of this document shall indicate compliance with the specified verification protocol requirements in order for this Certificate of Verification as a whole to be determined to be in compliance.

## 14. How to Read the Insulation Requirements on a CF1R-PRF-01

The CF1R-PRF-01-E (CF1R) lists the energy features required to meet the Title 24 Energy Code. It will include areas and orientations of all the surfaces of the home that impact the home's energy use: windows, skylights walls, doors, floors, ceilings, attics and roof. Different walls with different thermal properties (2x4 walls with R-15 vs 2x6 walls with R-21) will be modeled differently. The following steps will help you determine the minimum insulation required in all of the surfaces.

### 1. Make sure the CF1R is registered.

- It should have a CalCERTS logo watermark (a light image of the CalCERTS logo behind the text of the document on every page).
- It should also have a certificate number at the bottom of each page of the format 217-X#####X-##-##-#####-###" where "#" is a numeral and "X" is a letter.

### 2. Make sure the CF1R is current.

- Contact the "Responsible Designer" who signed the last page.
- Confirm with them that the registration date/time at the bottom of each page is the most current and that it is the one you should be bidding from. Ask if the project is participating in any above-code requirements. It is possible that the requirements might be different.

### 3. Confirm details in "General Information Section" – first section on first page.

### 4. Determine if QII is required.

- Find the "HERS Feature Summary" section, usually near the top of the second or third page.
- Look for the statement "**High quality insulation installation (QII)**". If it is on the list, QII is required.

HERS FEATURE SUMMARY	
The following is a summary of the features that must be field-verified by a certified HERS Rater as a condition for meeting the modeled energy performance for this computer analysis. Additional detail is provided in the building components tables below.	
Building-level Verifications: <ul style="list-style-type: none"> <li>• High quality insulation installation (QII) ←</li> <li>• IAQ mechanical ventilation</li> </ul> Cooling System Verifications: <ul style="list-style-type: none"> <li>• Verified EER</li> <li>• Verified SEER</li> <li>• Fan Efficacy Watts/CFM</li> </ul> HVAC Distribution System Verifications: <ul style="list-style-type: none"> <li>• Duct Sealing</li> <li>• Low-leakage Air Handling Unit</li> </ul> Domestic Hot Water System Verifications: <ul style="list-style-type: none"> <li>• -- None --</li> </ul>	<b>SAMPLE</b>

- c. If QII is required,
  - i. Evaluate plans very carefully. Look for unclear parts of thermal boundary. (Knee walls, hard covers, bump outs, fire places, etc.) These are common causes of fails.
  - ii. Define responsibilities for trades. (Air barriers, blocking, attic vents, sealing around fans, electrical boxes, insulated headers, etc.)
  - iii. Contact the HERS Rater for the project as soon as possible. Ask them for checklists, other informational materials.
  - iv. Meet at project early to discuss details of the QII requirements.
  - v. Learn to use CalCERTS registry.

**5. Find the “Opaque Surfaces” section.** This will show the walls, floors, and ceilings.

- a. Column 01 is the name of each surface being modeled. This is just a text field and has no impact on the simulation. Do not trust names like “R-15 Wall”. The actual R-value needs to be verified in the “Opaque Surfaces Construction” section.
- b. Column 02 is the name of the “zone” that the surface is adjacent to. If it shows two zones, such as “Main Conditioned Space>>>Garage”, this means that the surface separates these two zones. Even though the garage may have been modeled, it is not conditioned space and it would be very unusual to require insulation in the exterior walls of the garage. The surfaces that just say “garage” can usually be ignored.
- c. Column 03 is a construction assembly name that references a later section in the CF1R, “Opaque Surface Constructions” where there will be a detailed description of the construction of the surface (discussed below).
- d. Column 04 is the azimuth (direction) of the surface. 0=north, 90=east, 180=south, 270=west.
- e. Column 05 describes the side of the house that the surface is on.
- f. Column 06 is the gross area of the surface (includes windows and doors).
- g. Column 07 is the window and door area in that surface. Subtract column 07 from column 06 to get the net surface area (the area to be insulated). If any of these numbers deviate from your take-offs using the plans, you should contact the “Documentation Author” who signed the last page of the CF1R.
- h. Column 08 is the tilt of the surface. 0=horizontal, 90=vertical.

OPAQUE SURFACES							
01	02	03	04	05	06	07	08
Name	Zone	Construction	Azimuth	Orientation	Gross Area (ft <sup>2</sup> )	Window & Door Area (ft <sup>2</sup> )	Tilt (deg)
Front Wall 1	Main Conditioned Space	Construction Assembly 3	0	Front	160	60	90
Left Wall	Main Conditioned Space	Construction Assembly 3	90	Left	472	78	90
Back Wall 1	Main Conditioned Space	Construction Assembly 3	180	Back	450	175	90
Right Wall 1	Main Conditioned Space	Construction Assembly 3	270	Right	612	83.5	90
Front Interior Wall	Main Conditioned Space>>Garage	Construction Assembly 6			290	21.5	
Left Interior Wall 1	Main Conditioned Space>>Garage	Construction Assembly 6			137	0	
Ceiling (below attic) 1	Main Conditioned Space	Construction Assembly 2			2600		
Front Exterior Wall 1	Garage	Construction Assembly 7	0	Front	290	168	90
Left Exterior Wall 1	Garage	Construction Assembly 7	90	Left	185	21.5	90
Ceiling (below attic) 2	Garage	Construction Assembly 8			636		

**6. Find the “Attic” section.** This will tell you if the attic is ventilated or not and if ventilated, whether it is a “high performance attic (HPA)” or not. HPAs are ventilated attics with insulation at the attic floor (ceiling of house) **and** either above or below the roof deck.

- Column 01 is the Attic surface name. This is just a text field. Do not trust any R-values shown in the name. They should be confirmed in the “Opaque Surfaces Construction” section.
- Column 02 is a construction assembly name that references a later section in the CF1R, “Opaque Surface Constructions” where there will be a detailed description of the construction of the surface (discussed below).
- Column 03 will tell you if it is ventilated or not.
- Columns 04-08 describe the roof and any cool roof products or radiant barrier.

ATTIC							
01	02	03	04	05	06	07	08
Name	Construction	Type	Roof Rise	Roof Reflectance	Roof Emittance	Radiant Barrier	Cool Roof
Attic	Construction Assembly 5	Ventilated	5	0.15	0.91	No	No

**7. Find the “Opaque Surface Construction” section.** This is where the details of the construction assemblies can be found.

- Column 01 are the construction assembly names that were referenced in column 03 of the Opaque Surfaces section and column 02 of the Attic section. Again, names are always just text fields typed in by the documentation author. Do not trust R-values that appear in this column.
- Column 02 is the surface type
- Column 03 is the construction type.
- Column 04 describes the framing of the surface.



- e. Column 05 describes the R-value of the insulation installed in the surface cavity (between framing members).
- f. Column 06 describes the overall assembly U-factor. This is actually the most important number in terms of performance and compliance. It accounts for the entire assembly. If the U-factor is not met, it doesn't matter what R-value is installed.
- g. Column 07 describes the assembly layers. Look for insulation called "continuous" or "sheathing". This will be things like R-4 rigid polystyrene insulation installed on the exterior of the framing for 1-coat stucco systems.

OPAQUE SURFACE CONSTRUCTIONS						
01	02	03	04	05	06	07
Construction Name	Surface Type	Construction Type	Framing	Total Cavity R-value	Winter Design U-value	Assembly Layers
Construction Assembly 2	Ceilings (below attic)	Wood Framed Ceiling	2x4 Bottom Chord of Truss @ 24 in. O.C.	R 38	0.025	<ul style="list-style-type: none"> <li>• Inside Finish: Gypsum Board</li> <li>• Cavity / Frame: R-9.1 / 2x4 Btm Chrd</li> <li>• Over Ceiling Joists: R-28.9 insul.</li> </ul>
Construction Assembly 3	Exterior Walls	Wood Framed Wall	2x6 @ 24 in. O.C.	R 24	0.045	<ul style="list-style-type: none"> <li>• Inside Finish: Gypsum Board</li> <li>• Cavity / Frame: R-24 / 2x6</li> <li>• Sheathing / Insulation: Wood Siding/sheathing/decking</li> <li>• Exterior Finish: R4 Synthetic Stucco</li> </ul>
Construction Assembly 5	Attic Roofs	Wood Framed Ceiling	2x4 Top Chord of Roof Truss @ 24 in. O.C.	none	0.478	<ul style="list-style-type: none"> <li>• Inside Finish: Gypsum Board</li> <li>• Cavity / Frame: no insul. / 2x4 Top Chrd</li> <li>• Roof Deck: Wood Siding/sheathing/decking</li> <li>• Roofing: 10 PSF (RoofTile)</li> </ul>
Construction Assembly 6	Interior Walls	Wood Framed Wall	2x6 @ 24 in. O.C.	R 24	0.058	<ul style="list-style-type: none"> <li>• Inside Finish: Gypsum Board</li> <li>• Cavity / Frame: R-24 / 2x6</li> <li>• Other Side Finish: Gypsum Board</li> </ul>
Construction Assembly 7	Exterior Walls	Wood Framed Wall	2x4 @ 16 in. O.C.	none	0.361	<ul style="list-style-type: none"> <li>• Inside Finish: Gypsum Board</li> <li>• Cavity / Frame: no insul. / 2x4</li> <li>• Exterior Finish: 3 Coat Stucco</li> </ul>
Construction Assembly 8	Ceilings (below attic)	Wood Framed Ceiling	2x4 Bottom Chord of Truss @ 24 in. O.C.	none	0.481	<ul style="list-style-type: none"> <li>• Inside Finish: Gypsum Board</li> <li>• Cavity / Frame: no insul. / 2x4 Btm Chrd</li> </ul>

**8. Find the "Slab Floor" section.** Check column 05 for slab edge insulation. It's not very common, but if it's modeled, it must be installed.

**9. The "Building Envelope – HERS Verification Section" will reiterate that QII is required.**

## 15. QII Process by Construction Phase

	(1) Pre-design	(2) Design	(3) Design Review	(4) Grading	(5) Framing	(6) Rough-In	(7) Insulation	(8) Drywall	(9) Finish	(10) Final Inspection
(A) Energy Consultant	Specifies QII	Kickoff Meeting	Register CF1R, Assign Rater							
(B) Builder/ Architect	Approves, Selects Rater	Kickoff Meeting	Sign CF1R							Provide all Documents to Occupant
(C) HERS Rater		Kickoff Meeting	Sampling Details	Coordinate with Trades		ENV-21	ENV-22	ENV-22		
(D) Insulation Installer		Kickoff Meeting		Understand QII Requirements		Pre- Insulate	Install Insulation	Loosefill Ceiling Insulation	Finish CF2R's	
(E) Framer		Kickoff Meeting			Frame Continuous Air Barrier					
(F) Drywall Installer		Kickoff Meeting						Install and Seal Drywall		
(G) Misc. Trades		Kickoff Meeting			Hard Covers and Draft Stops	Caulk and Seal		Caulk and Seal		

- A1 Energy Consultant (EC) determines that QII is required to meet T-24 Energy Code.
- B1 Builder/Architect (B/A) approves CF1R with QII, acknowledges challenges and additional costs.
- A2-G2 All parties attend kickoff meeting and cover items in kickoff meeting checklists. Cover details.
- A3 EC registers CF1R in CalCERTS registry, signs as "Documentation Author", assigns rater, transfers project to rater.
- B3 B/A signs CF1R in registry as "Responsible Designer". Agrees to notify all trades of CF1R requirements. Specifies special QII requirements in contract with Insulation subcontractor, framer and all other affected trades. Determines sampling details with Rater.
- C3 Rater to propose sampling approach, details to B/A and trades. Set up sampling in registry.
- C4 Rater to coordinate QII details with affected trades, especially if sampling. Make sure they all have user access to registry.
- D4 Insulation installer to review and understand QII requirements (Handbook, etc.)
- E5 Framer to install framing according to plans and CF1R, paying special attention to continuous air barrier requirements.

- G5 Responsible trade to install hard covers and draft stops
- G6 Responsible trade to caulk and seal all framing penetrations, sign CF2R-ENV-21 in registry. (Pay attention to exterior wall channels, behind tubs and showers, etc.).
- D6 Insulation contractor to pre-insulate all cavities that might get covered up (exterior wall channels, behind tub and shower enclosures, etc.
- C6 Rater to complete ENV-21 checklist and forms in registry after D6 and G6 are completed.
- D7 Insulation contractor to install all insulation (except loose fill ceiling insulation) according to QII protocols. Complete and sign CF2R-ENV-03 and CF2R-ENV-22 in registry.
- C7 Rater to complete ENV-22 checklist and forms in registry after D7 is complete.
- F8 Drywall contractor to install drywall and caulk and seal all penetrations according to QII protocols.
- D8 After F8, installation and sealing of drywall, Insulation contractor to install loose fill ceiling insulation according to QII protocols. Complete and sign CF2R-ENV-22 in registry.
- C8 Rater to complete ENV-22 checklist and forms in registry after D8, F8, and G8 are complete.
- G8 Responsible trade to caulk and seal all remaining penetrations in drywall (register boots, ceiling fans, sprinklers, etc.).
- D9 Insulation contractor to finalize all CF2R forms in registry.
- C9 Rater to finalize all CF3R forms in registry.
- B10 Builder to make sure all trades have completed their CF2R forms (ALL Green Dots) and provide documentation packet to homeowner upon final inspection.



CalCERTS, Inc.  
31 Natoma Street, Suite 120  
Folsom, CA 95630

916-985-3400 Press \*

[Support@calcerts.com](mailto:Support@calcerts.com)